

EQUIPMENT  
SELECTION  
MADE EASY



# HOSPITAL CATALOGUE



---

# HOSPITAL EQUIPMENT CATALOGUE

© Copyright Aidacare Pty Ltd 2023

No part of this catalogue may be copied, distributed, reproduced, scanned or stored on any electronic database, whether in whole or in part in any form or by any means.

Due care has been taken to ensure all the information contained in this catalogue is correct at the time of printing. All measurements, pictures, colours and weight capacities are to be used as a guide only. We reserve the right to modify the design or appearance of any product displayed in this catalogue without prior notice.

P: 1300 133 120

W: [aidacare.com.au](http://aidacare.com.au)



# National Coverage

Aidacare have sales specialists and showrooms in more than 50 locations including both capital cities and regional locations across the country. We also have network of partners to ensure our products and service are easily accessible, nationwide.

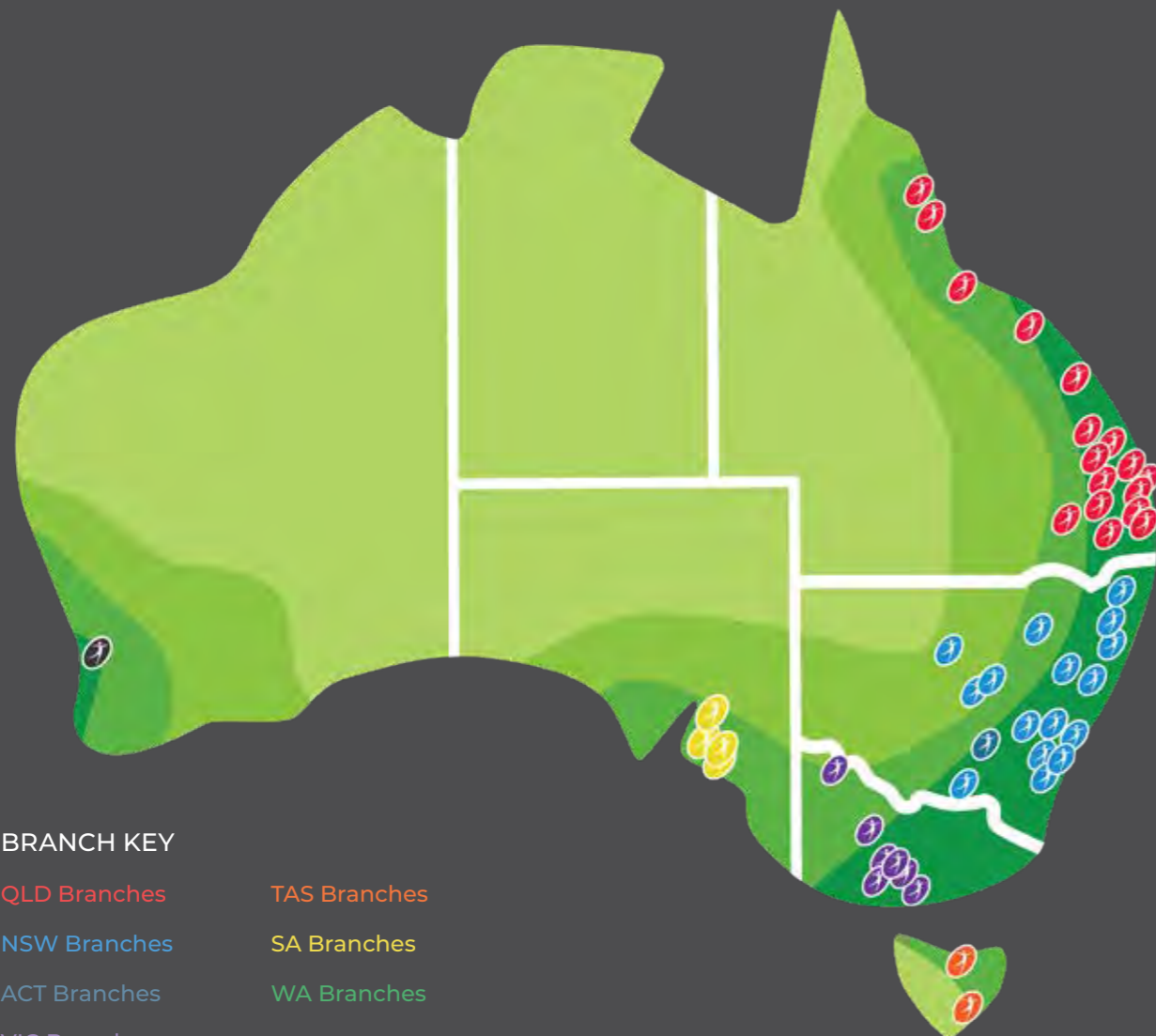

Our highly qualified equipment specialists and expert sales teams are available to tailor the best solutions for your facility, staff and patients. To get in touch with your nearest sales representative, visit [aidacare.com.au](http://aidacare.com.au) or call **1300 133 120**.

# Contents

01	Hospital Beds	5
02	Bedroom Furniture and Seating	11
03	Support Surfaces	23
04	Patient Trolleys	29
05	Patient Hygiene	35
06	Patient Transport and Mobility	45
07	Pressure Relief Chairs	57
08	Sanitisers and Macerators	69
09	Maternity	79
10	Patient Handling: Mobile	83
11	Patient Handling: Ceiling Systems	99
12	Movement and Therapy	107
13	Falls Prevention	111
14	Trolleys and Carts	119
15	Treatment Chairs	137
16	Examination Couches and Equipment	141
17	Workstations on Wheels	147
18	Electronic Medication Management	153
19	Hospital Mortuary and Funeral Home	159
20	Bariatric	169

# Hospital Beds

---

Aidacare's hospital beds cater to the specific needs of a busy ward environment. With patient health and comfort in mind, our hospital beds offer an economical and versatile solution for all types of hospitals and medical facilities. High-quality, durable components and robust construction mean these hospital beds are designed to last.

Features include electronic controls, a backup battery, and a myriad of positioning options to reduce manual handling and enhance patient comfort. With the addition of a hospital-grade mattress, these hospital beds are suited for general patient care, rehabilitation, or patients with high-risk care needs.

Choose from a range of hospital beds for sale, including medical beds, hi-lo positioning beds, ward beds and ICU beds.



# ARIA ICU Bed

The ARIA ICU bed is designed with patient and care staff welfare in mind. It offers integrated features to ease care staff burden whilst creating a comfortable and effective patient support surface.



### Incentro System

Combines back and pelvic nullifies horizontal forces, prevents slipping and keeps the body at a 30° angle, optimal for ventilation.

### Alarms

Braking Light/Sound Alarm and Automatic Self-Brake Orange Light indicate the unsafe mattress platform height, and green means it is safe.

Once connected to power, an alarm sound alerts the nursing staff if the bed remains 'Un-Braked'.



**BIOCOTE**  
Antibacterial frame coating for improved infection control



### Bed Lengthener

300mm of extension to cater for taller patients



### X-Ray Tray

Allows easy x-ray operations to be carried out (available upon request)



### Blanket & Nurse Control Panel Holder

Extractable tray for blankets and nurse control panel

**1 YEAR WARRANTY**  
Handset

**3 YEARS WARRANTY**  
Electrics

**10 YEARS WARRANTY**  
Frame



Code	BEB050160
Overall Length	2200 - 2500mm
Overall Width	990mm
Overall Height	460-820mm
Backrest Angle	0° - 63°
Knee Break Angle	0° - 30°
Leg Section	-16° - +16° (as against the horizontal)
Trendelenburg +/-	13° / -13°
Castor Size	150mm
Product Weight	185kg
SWL	300kg

### Features and Benefits

- Lateral tilting patient surface programmable for individual patient needs between +/- 18°
- Radio transparent patient surface for fluoroscopic examinations
- Intuitive control panels within the gas-assisted folding sides provide fast and effective positioning of the patient support surface.
- Integrated weigh scale
- DeltaDrive powered wheel allows ease of movement of bed by care staff with an easy toggle operation from the head end of the bed
- Accessory bars on both sides of the bed to store accessories such as drainage bags
- Braking light/sound alarm and automatic self-braking for improved safety (available upon request)

# Delta Ward Bed

A new generation of beds developed according to the needs of healthcare professionals, with an idea in mind: if the bed allows the operators to work at their best, the patient's well-being follows naturally.



### Incentro System

Combines back and pelvic nullifies horizontal forces, prevents slipping and keeps the body at a 30° angle, optimal for ventilation.

### Alarms

Braking Light/Sound Alarm and Automatic Self-Brake Orange Light indicate the unsafe mattress platform height, and green means it is safe.

Once connected to power, an alarm sound alerts the nursing staff if the bed remains 'Un-Braked'.



### Bed Lengthener

300mm of extension to cater for taller patients



### X-Ray Tray

Allows easy x-ray operations to be carried out (available upon request)



### Blanket & Nurse Control Panel Holder

Extractable tray for blankets and nurse control panel



**BIOCOTE**  
Antibacterial frame coating for improved infection control



**1 YEAR WARRANTY**  
Handset

**3 YEARS WARRANTY**  
Electrics

**10 YEARS WARRANTY**  
Frame

### Features and Benefits

- Four sector safety sides with electric controls allow full autonomy of movement to the patient
- Safe exit control moves the mattress platform to the minimum height and lifts the backrest to facilitate the patient getting up from the bed
- Bed lengthener
- Electric foot pedals
- CPR control on both sides allows the bed platform to be brought to the horizontal position immediately; accessible even with the side rail lowered
- Removable headboard and footboard for emergency operations
- Automatic self brake, braking sound alarm with orange/green light (available upon request)
- Extractable tray for blankets and nurse control panel
- Electric adjustable footrest

Code	BEB050140 BEB050155 with Weigh Scale BEB050145 with Delta Drive BEB050150 with Weigh Scale and Delta Drive
Overall Length	2200mm
Overall Width	990mm
Overall Height	390 - 790mm
Backrest Angle	0° - 65°
Knee-Break Angle	0° - 30°
Leg Section	-10° - +10° (as against the horizontal)
Trendelenburg +/-	+16° / -16°
Castor Size	125mm
Product Weight	125kg
SWL	300kg

# Botero Bariatric Ward Bed



The specific bariatric design focus offers width and length adjustable deck to manage changing needs in both ward and respite environments.



### OPTIONAL ACCESSORIES

- Static Mattress with Extension Bolster (BEM050200)
- Self Help Pole (BEA825100)
- Telescopic IV Pole (BEA825101)
- Catheter Bag Holder (BEA825103)
- Accessory Bag Holder (BEA825104)
- Oxygen Bottle Holder (BEA825105)

**Integrated Bed Width Extension**  
 1020 → 1220  
 Tool free extension for changing needs

**Integrated Bed Length Extension**  
 180mm of extension to cater for taller patients

**Attendant Control Panel**  
 Single touch functions for speed and simplicity

- BARIATRIC
- CPR FUNCTION
- BATTERY BACK-UP
- OPTIONAL DRIVE WHEEL
- BIOCOTE Antibacterial frame coating for improved infection control

- SWL 400kg
- 1 YEAR WARRANTY Handset**
- 3 YEARS WARRANTY Electrics**
- 10 YEARS WARRANTY Frame**

<b>Code</b>	BEB050200
	BEB050201 (Includes Integrated Weigh Scale)
<b>Overall Length</b>	2260 - 2440mm
<b>Overall Width</b>	1020 - 1220mm
<b>Overall Height</b>	380 - 850mm
<b>Patient Surface Length</b>	2000 - 2180mm
<b>Patient Surface Width</b>	1020 - 1220mm
<b>Backrest Angle</b>	0° - 70°
<b>Knee Bend Angle</b>	0° - 30°
<b>Trendelenburg</b>	-17° / 17°
<b>Castor Size</b>	150mm
<b>SWL</b>	400kg

### Features and Benefits

- Low height of 380mm
- Backrest translation (autoregression) reduces compression of the thoracic and abdominal areas as the backrest is raised and alleviates shear and pressure for improved skin integrity
- Compatible with all leading bed movers
- Attendant control panel with intuitive pre-programmed single touch functions for speed and simplicity
- 150mm Tente castors
- Central locking castors with integrated directional lock
- Full Trendelenburg functionality
- Integrated folding side rails
- Removable width adjustable head and foot panels

# FL250 Floorline Acute Bed



Our most popular Floorline bed has the ability to be converted for hospital/acute use with key elements such as removable bed ends, molded plastic components for improved infection control, and full CPR functionality.



- CPR FUNCTION
- BATTERY BACK-UP
- Handset**  
Intuitive backlit handset with CPR function

### Standard Compliance

Aidacare FL250 Beds are designed and manufactured in compliance with International Medical Device Safety standard IEC60601-1, IEC60601-2-52. All electronics are designed for use in Acute Care environments and comply with all relevant Electrical Safety Standards.

### Conversion Kit

- Conversion Kit improves the functionality of the bed.
- The kit contains:
- Handset with CPR
  - Nurse Control Panel with CPR
  - Bed End
  - Brackets
  - Molded Plastic Bed Ends

### OPTIONAL ACCESSORIES

- Folding Assist Bar (BEB046520)
- Folding Side Rail (BEB046525)
- IV Pole (BEB046530)
- Self Help Pole (BEB046540)



- 1 YEAR WARRANTY Handset**
- 3 YEARS WARRANTY Electrics**
- 10 YEARS WARRANTY Frame**

### Features and Benefits

- SmartDescent automatically slows descent speed allowing possible impingements to be identified and moved
- Auto-regression in backrest and knee break for hear-force reduction
- Chair positioning - improves pressure management and respiration and more comfortable dining and sitting position
- Underbed lighting provides enhanced night navigation for falls prevention
- Mattress retainers located at sides and foot end (extendable)
- Foot activated In-line central locking brakes are colour coded for enhanced usability
- Control panel - convenient mobile nurse control panel with CPR functionality for efficient care delivery
- Removable bar ends - medical grade plastic for improved response times and effective infection control

<b>Codes</b>	BEB046100 - Single	BEB046150 - King Single
<b>Conversion Kit</b>	BEB046235	BEB046235
<b>Patient Surface</b>	2000 x 900mm	2000 x 1060mm
<b>Overall Width</b>	900mm	1060mm
<b>Length Extension</b>	100 / 200mm	
<b>Patient Surface Height Range</b>	110 to 740mm	
<b>Backrest Range</b>	0 - 600	
<b>Knee Bend Range</b>	0 - 350	
<b>Mattress Platform</b>	4 Sections	
<b>CPR Activation</b>	Within 10 seconds	
<b>Castors</b>	8 x Twin 75mm	
<b>Product Weight</b>	105kg	115kg
<b>SWL</b>	250kg	



# Bedroom Furniture and Seating

---

We offer bedroom furniture and accessories to create a welcoming and functional space for residents and their visitors. For those experiencing mobility challenges, proper seating and support are essential to feeling comfortable and staying free from pain.

From height adjustable chairs to those designed to relieve pressure, our selection of bedroom furniture and seating can provide comfort and support for a range of needs. We also offer an excellent assortment of medical lounge chairs for use in waiting rooms and reception areas.

## Recovery Chair



The Aspire Recovery Chair offers a comfortable seating surface in-room or in a mobile configuration.

- Three comfort positions
- Adjustable padded neck pillow for postural support
- Mobility castor option for patient transportation
- Comfortable padded arms with tapered front upright for improved table access
- Lightweight and easy to move promoting workplace health and safety

### COLOUR OPTIONS

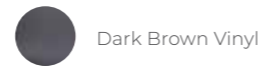

Dark Brown Vinyl

Code	CHP198820
Overall Height	1080mm
Overall Width	690mm
Overall Depth	780mm
Seat Height	420mm
Seat Width	520mm
Seat Depth	580mm
Backrest Height	660mm
SWL	150kg



## Sleeper Chair



The Aspire Sleeper Chair converts from a chair to a comfortable sleeping surface.

- Durable seat construction preserves shape and comfort in a high use environment
- Intuitive single hand activation allows effortless conversion from chair to a sleeping surface
- Recessed locking castors offer easy positioning and accessibility
- Completely flat sleep surface to maximise rest and relaxation
- Contemporary design compliments a range of care environments

### COLOUR OPTIONS

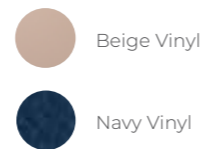

Beige Vinyl

Navy Vinyl

Code	CHP198810 - Beige CHP198816 - Navy
Overall Height	780mm
Overall Width	760mm
Overall Depth	960mm
Seat Height	370mm
Seat Width	600mm
Seat Depth	580mm
Backrest Height	410mm
SWL	150kg



Completely flat sleep surface to maximise rest and relaxation



## Dialysis Chair



The Aspire Dialysis Chair offers a comfortable seating surface in-room or in a mobile configuration for infusion therapy.

- Tapered fold down armrests promote comfort and accessibility during infusion therapy
- Intuitive recline mechanism for patient independence
- Three comfort positions
- IV pole mounted to rear of chair
- Mobility castor option for patient transportation
- Lightweight and easy to move promoting workplace health and safety

### COLOUR OPTIONS



Beige Vinyl

Navy Vinyl

Code	CHT100400 - Beige CHT100405 - Navy
Overall Height	1080mm
Overall Width	690mm
Overall Depth	780mm
Seat Height	420mm
Seat Width	520mm
Seat Depth	580mm
Backrest Height	660mm
SWL	150kg



Intuitive recline mechanism for patient independence



ARTG - 298405

## Classic Lowback Day Chair



- Contoured backrest for postural support
- Softly padded armrests
- Lightweight yet sturdy design
- Powder coated steel frame
- Easy clean vinyl surfaces
- Height adjustable legs with easy push button
- Non-slip tips provide stability

### COLOUR OPTIONS



Champagne Vinyl

Slate Vinyl

### OPTIONAL ACCESSORIES

- Adjustable Padded Legrest
- Champagne Vinyl (CHP208080)
- Slate Vinyl (CHP208085)



Height adjustable legs



ARTG - 230087

Code	CHP208000 - Champagne CHP208005 - Slate
Overall Height	865-1015mm
Overall Width	580mm
Overall Depth	500mm
Seat Height	450-605mm
Seat Width	460mm
Seat Depth	440mm
Backrest Height	440mm
SWL	160kg

## Classic Highback Day Chair



- Contoured backrest for postural support
- Softly padded armrests
- Lightweight yet sturdy design
- Powder coated steel frame
- Easy clean vinyl surfaces
- Height adjustable legs - easy push button
- Non-slip tips provide stability
- Adjustable chair legrest (optional)



Height adjustable

### COLOUR OPTIONS

- Champagne Vinyl
- Slate Vinyl

### OPTIONAL ACCESSORIES

- Adjustable Padded Legrest
- Champagne Vinyl (CHP208080)
- Slate Vinyl (CHP208085)

<b>Code</b>	CHP208050 - Champagne CHP208055 - Slate
<b>Overall Height</b>	1160-1312mm
<b>Overall Width</b>	645mm
<b>Overall Depth</b>	600mm
<b>Seat Height</b>	425-610mm
<b>Seat Width</b>	490mm
<b>Seat Depth</b>	490mm
<b>Backrest Height</b>	720mm
<b>SWL</b>	160kg



ARTG - 230087

## Adjustable Highback Day Chair



- A high back orthopaedic chair that offers adjustability, comfort, and support
- Padded headrest cushion, seat and armrests, and contoured backrest provides postural support and pressure distribution
- Sturdy lightweight design for easy manoeuvrability
- Transport wheels allows for the chair to be moved with ease by carers
- Height, width, and depth adjustable to accommodates changing user needs
- Non-slip tips
- Powder coated steel frame



Height, width, and depth adjustable



Push handle and transport wheels

### COLOUR OPTIONS

- Latte Vinyl
- Ink Vinyl

<b>Code</b>	CHP208025 - Latte CHP208030 - Ink
<b>Overall Height</b>	1070 - 1220mm
<b>Overall Width</b>	575 - 675mm
<b>Overall Depth</b>	760 - 860mm
<b>Seat Height</b>	410 - 530mm
<b>Seat Width</b>	510 - 610mm
<b>Seat Depth</b>	475 - 590mm
<b>Backrest Height</b>	740 - 790mm
<b>SWL</b>	160kg



ARTG - 230087

## Pressure Reducing Adjustable Highback Day Chair



- Carrflex™ PU 4-way stretch fabric for superior chemical resistance, flexibility, and breathability
- Memory foam for a comfortable and supportive surface
- Maximised immersion and envelopment
- Contoured seat and backrest padding
- Head cushion height adjustable and removable
- Height adjustable legs with easy push button adjustment
- Tool free adjustment
- Push handle and transport wheels



ARTG - 230087

### COLOUR OPTIONS

- Ink Multistretch

<b>Code</b>	CHP208035 - Ink
<b>Overall Height</b>	1070-1220mm
<b>Overall Width</b>	575-675mm
<b>Overall Depth</b>	760-860mm
<b>Seat Depth</b>	410-530mm
<b>Seat Width</b>	510-610mm
<b>Seat Height</b>	475-590mm
<b>Backrest Height</b>	740-790mm
<b>SWL</b>	160kg

## MAXI Adjustable Highback Day Chair



- Sturdy, flexible design for added stability and safety for larger users
- Ergonomic seat with anterior tilt to improve posture and reduce fatigue
- Height, width, and depth adjustability in seat and back, for superior customised comfort
- Easily manoeuvrable with push handle and transport wheels
- Easy clean, breathable and comfortable vinyl upholstery, and powder coated frame



ARTG - 230087

### COLOUR OPTIONS

- Burgundy Vinyl

<b>Code</b>	CHP208010 - Burgundy
<b>Overall Height</b>	1120 - 1440mm
<b>Overall Width</b>	600 - 810mm
<b>Overall Depth</b>	850 - 990mm
<b>Seat Depth</b>	390 - 530mm
<b>Seat Width</b>	600 - 810mm
<b>Seat Height</b>	370 - 520mm
<b>Backrest Height</b>	1120 - 1340mm
<b>SWL</b>	310kg



Height, width, and depth adjustable

## Waterfall Highback Day Chair



- Waterfall backrest provides comfort and support
- Removable cushion sections
- Padded seat and armrests
- Powder coated steel frame
- Non-slip tips provide stability
- Height adjustable
- Sturdy design - high safe working load yet lightweight for easy manoeuvrability



ARTG - 230087

### COLOUR OPTIONS

- Mocha Fabric
- Latte Vinyl
- Oatmeal Fabric
- Ink Vinyl

<b>Code</b>	CHP208071 - Latte CHP208070 - Ink CHP208075 - Mocha CHP208076 - Oatmeal
<b>Overall Height</b>	1020 - 1190mm
<b>Overall Width</b>	730mm
<b>Overall Depth</b>	740mm
<b>Seat Depth</b>	490mm
<b>Seat Width</b>	510mm
<b>Seat Height</b>	400 - 550mm
<b>Backrest Height</b>	680mm
<b>SWL</b>	160kg



Height adjustable



### BC4 Highback Day Chair



- Versatile and stylish patient chair
- Full memory foam layer on seat and backrest
- Built in postural and ergonomic design with fixed steel frame
- Luxurious pressure relieving comfort
- Adjustable seat height and depth
- Range of vinyls or fabric
- 10 year structural warranty
- Range of upholstered finishes and colours available

#### COLOUR OPTIONS

- Latte Vinyl
- Ink Vinyl

<b>Code</b>	CHP208025 - Latte CHP208030 - Ink
<b>Overall Height</b>	990 - 1170
<b>Overall Width</b>	630mm
<b>Overall Depth</b>	780mm
<b>Seat Height</b>	440 - 590mm
<b>Seat Width</b>	510mm
<b>Seat Depth</b>	440 - 550mm
<b>Backrest Height</b>	600mm
<b>SWL</b>	160kg

SWL 160kg 1 YEAR WARRANTY

ARTG - 230087

### BC1 Low Back Day Chair



- Stylish orthopaedic ergonomic lowback chair
- Padded armrests and padded fixed one piece shell
- Fully adjustable seat height
- Powder coated steel frame
- Range of upholstered finishes and colours available

#### COLOUR OPTIONS

- Latte Vinyl
- Ink Vinyl

<b>Code</b>	CHP196706 - Latte CHP196705 - Ink
<b>Overall Height</b>	840 - 990mm
<b>Overall Width</b>	730mm
<b>Overall Depth</b>	740mm
<b>Seat Depth</b>	490mm
<b>Seat Width</b>	510mm
<b>Seat Height</b>	370 - 520mm
<b>Backrest Height</b>	550mm
<b>SWL</b>	160kg

SWL 160kg 1 YEAR WARRANTY

ARTG - 230087

### BC1 Highback Day Chair



- Stylish orthopaedic ergonomic highback chair
- Padded armrests and padded fixed one piece shell
- Fully adjustable seat height
- Powder coated steel frame
- Range of upholstered finishes and colours available

#### COLOUR OPTIONS

- Latte Vinyl
- Ink Vinyl

<b>Code</b>	CHP196506 - Latte CHP196505 - Ink
<b>Overall Height</b>	990 - 1140mm
<b>Overall Width</b>	730mm
<b>Overall Depth</b>	740mm
<b>Seat Height</b>	370 - 520mm
<b>Seat Width</b>	510mm
<b>Seat Depth</b>	490mm
<b>Backrest Height</b>	650mm
<b>SWL</b>	160kg

SWL 160kg 1 YEAR WARRANTY

ARTG - 230087

### BC1 Kingsize Highback Day Chair



- Stylish orthopaedic ergonomic highback chair
- Padded armrests and padded fixed one piece shell
- Fully adjustable seat height
- Powder coated steel frame
- Range of upholstered finishes and colours available

#### COLOUR OPTIONS

- Latte Vinyl
- Ink Vinyl

<b>Code</b>	CHP196519 - Ink CHP196520 - Latte
<b>Overall Height</b>	990 - 1140mm
<b>Overall Width</b>	820mm
<b>Overall Depth</b>	740mm
<b>Seat Height</b>	370 - 520mm
<b>Seat Width</b>	600mm
<b>Seat Depth</b>	490mm
<b>Backrest Height</b>	650mm
<b>SWL</b>	220kg

SWL 220kg 1 YEAR WARRANTY

ARTG - 230087

### Classic Bedside Commode



- Allows for toileting in the bed room for users unable to travel between the bedroom and bathroom
- Raised padded armrests
- Easy clean vinyl surfaces
- Removable, padded seat
- Three-sided shroud – discreetly conceals bowl
- Non-slip rubber tips

#### COLOUR OPTIONS

- Champagne Vinyl
- Slate Vinyl

<b>Code</b>	BEC045005 - Champagne BEC045006 - Slate
<b>Overall Height</b>	915 - 1040mm
<b>Overall Width</b>	570mm
<b>Overall Depth</b>	570mm
<b>Seat Height</b>	490 - 615mm
<b>Seat Width</b>	450mm
<b>Seat Depth</b>	440mm
<b>Backrest Height</b>	455mm
<b>SWL</b>	125kg

SWL 125kg 1 YEAR WARRANTY

ARTG - 230171



Removable bowl with lid and carry handle

### Deluxe Bedside Commode



- Deeply padded comfortable seat, back, and armrests
- Removable bowl with lid and carry handle
- Easy clean vinyl surfaces
- Lift-up padded seat
- Height adjustable
- Three-sided shroud discreetly conceals bowl
- Non-slip rubber tips

#### COLOUR OPTIONS

- Champagne Vinyl
- Slate Vinyl

<b>Code</b>	BEC045115 - Champagne BEC045116 - Slate
<b>Overall Height</b>	865 - 1015mm
<b>Overall Width</b>	600mm
<b>Overall Depth</b>	520mm
<b>Seat Height</b>	410 - 565mm
<b>Seat Width</b>	460mm
<b>Seat Depth</b>	450mm
<b>Backrest Height</b>	425mm
<b>SWL</b>	160kg

SWL 160kg 1 YEAR WARRANTY

ARTG - 230171



Removable bowl with lid and carry handle



## Perching Stool



- Designed to facilitate regular sitting and standing assistance
- Generously padded seat and back support surfaces
- Raised armrests assist the user transferring on and off the stool
- Seat with anterior tilt facilitates standing from sitting and provides greater comfort for stiff or painful hips
- Height adjustable legs with easy push button adjustment and non-slip rubber tips for stability

### COLOUR OPTIONS

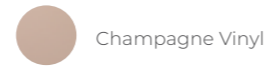

<b>Code</b>	CHP213500 - Champagne
<b>Overall Height</b>	940 - 1090mm
<b>Overall Width</b>	550mm
<b>Overall Depth</b>	470mm
<b>Seat Height</b>	640 - 690mm
<b>Seat Width</b>	375mm
<b>Seat Depth</b>	310mm
<b>Backrest Height</b>	440mm
<b>SWL</b>	175kg

SWL 175kg

1 YEAR WARRANTY



Seat with anterior tilt

ARTG - 230087

## Transport Legs with Wheels



Code	Description
CHP208090	Transport Legs with Wheels - Aspire High Back, BC2 Waterfall & Adjustable Day Chairs

ARTG - 230087

## Footrest



Code	Description
CHP208090	Footrest - Champagne Vinyl
CHP208085	Footrest - Slate Vinyl

ARTG - 230087

## Overchair Table



- Contoured design for user comfort and additional support, for those with reduced upright sitting strength
- Width adjustment accommodates recliners, chairs, and beds up to 1120mm wide
- Raised safety trims keep items from sliding off
- Height adjustment accommodates varying chair and bed heights
- Durable laminate table top and powder coated frame
- Large table top accommodates food trays, personal items, and provides a stable writing surface
- Locking castors for improved stability

### COLOUR OPTIONS



### IN USE



<b>Code</b>	BEA028150
<b>Height Range</b>	710 - 910mm
<b>Tabletop Width</b>	505mm
<b>Tabletop Length</b>	1000 - 1200mm

1 YEAR WARRANTY

18

## Laminate & Custom Overbed Tables



- Stable and secure table top to conveniently accommodate meals, drinks, reading materials, tablet devices, and other items within easy arms reach from a bed or chair
- Height adjustment lever is easily accessible to users and carers
- Height fixing knob will lock the height and prevent adjustment by users
- Two locking castors for securing table position by the carer to prevent rolling

### TABLE TOP

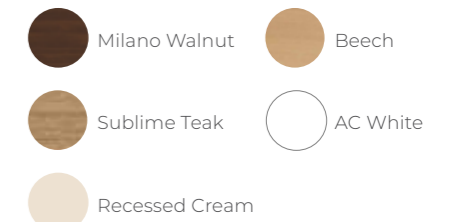

### FRAME



<b>Table Top Code</b>	BEA006695 - Sublime Teak BEA006696 - Milano Walnut BEA006694 - Beech BEA006693 - AC White BEA006691 - Recessed Cream
<b>Frame Code</b>	BEA006685 - Gunmetal Grey BEA006690 - Beige
<b>Height Range</b>	730 - 1095mm
<b>Tabletop Width</b>	800mm
<b>Tabletop Length</b>	430mm
<b>Internal Base Width</b>	670mm

### STANDARD OPTIONS

- Option 1 (Shown)  
Beige Frame, White Top (BEA006700)
- Option 2  
Beige Frame, Beech Top (BEA006701)
- Option 3  
Gunmetal Grey Frame, Sublime Teak Top (BEA006705)
- Option 4  
Gunmetal Grey Frame, Milano Walnut Top (BEA006706)



1 YEAR WARRANTY

ARTG - 242920

## Recessed Top Overbed Table



- Recessed thermoform top
- Lightweight mobile table
- Flat top ideal for hospital or home use
- Fully height adjustable
- 'C' base shape, four castors for close positioning to bedside or chair
- Powder coated mild steel frame
- Cream standard laminate top with thermoform (heat resistant vinyl) edging

### COLOUR OPTIONS

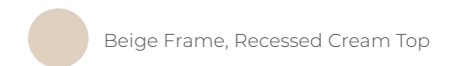

<b>Code</b>	BEA028000 - Beige Frame / Cream Top
<b>Height Range</b>	730 - 1095mm
<b>Tabletop Width</b>	800mm
<b>Tabletop Length</b>	430mm
<b>Internal Base Width</b>	670mm



1 YEAR WARRANTY

ARTG - 242920

## Recessed Split Top Overbed Table



- Internal width of 800mm for use around common lift recline chairs
- Recessed thermoform top, lightweight mobile tilting table
- Angle adjustable to 45 degrees
- Side table does not tilt
- Fully height adjustable
- 'C' base shape, four castors for close positioning to bedside or chair
- Powder coated mild steel frame

### COLOUR OPTIONS



<b>Code</b>	BEA028100 - Beige Frame / Cream Top
<b>Height Range</b>	710 - 1070mm
<b>Tabletop Width</b>	800mm
<b>Tabletop Length</b>	430mm
<b>Tilt Section Length</b>	600mm
<b>Fixed Section Length</b>	200mm
<b>Internal Base Width</b>	800mm



1 YEAR WARRANTY

ARTG - 242920

19

## Bedside Cabinets

- Available in two different surface finishes – laminate and compact
- Laminate finish designed to match modern room decor
- Compact surface is highly durable and robust, catering to acute environments
- Easy to clean for improved infection control
- Four castors for easy positioning and accessibility
- Aluminum corner uprights minimise wear over time (compact models)
- Colour contrasting, easy to see handles
- Soft closing drawer runners

### Austin Bedside Cabinet



Hutch attachment available

### Belinda Bedside Cabinet



Hutch attachment available

### Chelsea Bedside Cabinet



Hutch attachment available

### Derik Bedside Cabinet



Hutch attachment available

	Code	Product	Overall Height	Overall Width	Overall Depth
A	BEA826300	Austin Bedside Cabinet	810mm	465mm	450mm
	BEA826305 with Hutch		1020mm	465mm	450mm
B	BEA826310	Belinda Bedside Cabinet	810mm	465mm	450mm
	BEA826315 with Hutch		1020mm	465mm	450mm
C	BEA826320	Chelsea Bedside Cabinet	810mm	465mm	450mm
	BEA826330 with Hutch		1020mm	465mm	450mm
D	BEA826340	Derik Bedside Cabinet	810mm	465mm	450mm
	BEA826350 with Hutch		1020mm	465mm	450mm

## Bed Cradle - Height Adjustable



- Designed to keep bed linen off sensitive areas of lower leg or feet by creating clearance between bed linen and the mattress
- Lower frame slides underneath mattress, securing cradle to bed, while upper frame is positioned horizontally over the lower limbs
- Bedding is placed over the frame to remove any weight or pressure
- Height adjustable frame allows the user to customise the space between mattress surface and bedding
- Powder coated mild steel construction

Code	BEA014610
Height	440 - 640mm

**1** YEAR WARRANTY

ARTG - 290769



## Bedside Cabinet - Single



- Bedside cabinet with extension shelf
- Powder coated steel cabinet with plastic finishings, wipe clean and ideal for infection control management
- Pull out towel rail
- Raised edges for fluid retention around the perimeter of shelves
- EASY SYSTEM allows for over bed table integration
- 4 x 50mm twin castors (2 x locking)

Code	BEA827160
Width	500mm
Depth	500mm
Height	940mm

## Bedside Cabinet - Dual



- Bedside cabinet without extension shelf
- Powder coated steel cabinet with plastic finishings, wipe clean and ideal for infection control management
- Pull out towel rail
- Raised edges for fluid retention around the perimeter of shelves
- EASY SYSTEM allows for over bed table integration
- 4 x 50mm twin castors (2 x locking)

Code	BEA827165
Width	500mm
Depth	480mm
Height	770mm

## Overbed Table



- Large operating range with 270mm worth of movement via an easy gas assisted telescopic column
- Complete with bottle holder/storage area with four compartments
- Compatible for fitting on either side of the single and dual fronted bedside cabinets

Code	BEA827170
Width	630mm
Depth	410mm
Height	880 - 1150mm

# Support Surfaces

---

The Aspire **LIFECOMFORT**<sup>®</sup>, **HYBRID**, and **ACTIVE AIR** mattresses have set the benchmark in sleep surface quality and performance in Australia.

They are fitted with superior hospital grade polyurethane coated covers designed to withstand the rigors of usage and cleaning requirements in all environments up to the most stringent hospital infection control.

Multiple available combinations of foam or alternating air layers provide maximum comfort, support, and pressure redistribution across a very wide spectrum of user sizes, shapes, and pressure care needs.

# LIFECOMFORT® MATTRESSES

## SUB-ACUTE AND HOSPITAL FOCUSED PRESSURE REDISTRIBUTION



LIFECOMFORT® MATTRESSES cater to a broad spectrum of Pressure Care risk ratings from low to high.

Engineered to suit the broad patient weight requirements and pressure care needs of acute care environments. Reinforced hinged sidewalls assist transfer efficiency and accentuate the sleep surface edge. Layered sleep surface maximises pressure redistribution and immersion for patient comfort and improved sleep quality.

### STANDARD INCLUSION

- **Durable hospital grade foam** that is treated for antimicrobial and antibacterial properties.
- **Breathable, 4-way stretch waterproof cover** to reduce shear, friction and maintain skin microclimate
- **Medical grade waterfall covers** are fully-welded over the zipper to maximise infection control
- **Asset management ready** with unique batch and serial numbers printed on all covers

### CLINICAL BENEFITS



### STANDARD FEATURES



### LIFE CYCLE & COMPLIANCE

- Warranty: 5 yrs Foam | 5 yrs Cover
- Machine Washable Covers: Up to 950
- Safe Working Load Verified: AS/NZ 2282
- Durability + Performance: ISO 3385
- Flame Retardant Foam + Covers: AS/NZ 4088.1 Cribs 5.
- TGA: Lifecomfort Mattresses are registered in the ARTG, AUST R ARTG 288486

### CUSTOMISATION

- **Unique User Needs:** Palliative, unusual body shapes, zoning needs, ROHO inserts or specific mattress sizes
- **Facility Asset Management:** Customised labelling for institutional orders



## Acute Care Mattress

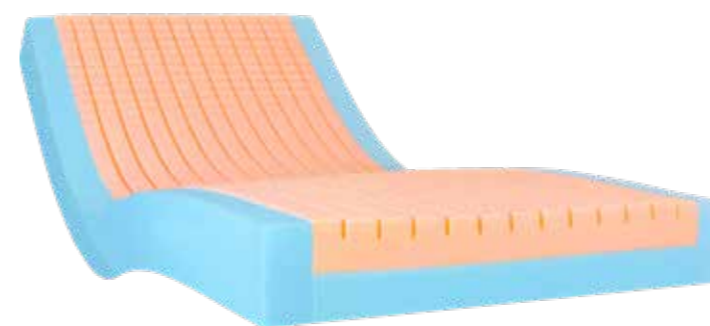

### APPLICATIONS

- Hospital
- Age Care
- Home Care
- Palliative Care



### FOAM LAYERS



Code	BEM046615 - Single	BEM046616 - King Single
Overall Length	1980mm	2030mm
Overall Width	880mm	1050mm
Overall Height	150mm	150mm
Effective Weight Range	50 - 250kg	

ARTG - 288486



## Bariatric Mattress



### APPLICATIONS

- Hospital
- Home Care
- Palliative Care
- Bariatric Care
- Age Care



### FOAM LAYERS

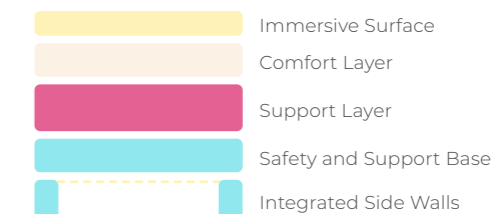

Code	BEM046700	
Overall Length	2030mm	
Overall Width	1050mm	
Overall Height	200mm	
Effective Weight Range	50 - 300kg	

ARTG - 288486



## Premier Care Acute Mattress



### APPLICATIONS

- Hospital
- Home Care
- Palliative Care
- Respite Care
- Age Care



- MEMair BREEZE™ - Top foam layer offers leading breathability for a cooler more immersive sleep surface
- Convoluted second layer coupled with varying foam grades
- Multi-stretch top with waterfall zipper covers prevents fluid ingress for easier management of infection control
- Reinforced side walls for patient stability when entering and exiting the bed
- Hinged foam core allows the mattress to move with profiling bed surfaces

### FOAM LAYERS

- Immersive Surface
- Comfort Layer
- Safety and Support Base
- Integrated Side Walls

Code	BEM046735 - Single	BEM046740 - King Single
Overall Length	2000mm	2030mm
Overall Width	900mm	1050mm
Overall Height	150mm	150mm
Effective Weight Range	30 - 250kg	

EFFECTIVE WEIGHT RANGE: **30-250KG**

**5 YEARS WARRANTY**  
Cover

**5 YEARS WARRANTY**  
Foam

ARTG - 288486



## Active Air® Acute 8 with



### OPTIONAL ACCESSORIES

- Rapid Inflation Turbo Pump (PTM639000)

EFFECTIVE WEIGHT RANGE: **30-250KG**

**2 YEARS WARRANTY**  
Pump

**2 YEARS WARRANTY**  
Replacement

ARTG - 293518

- Designed to meet the demands of critical care environments, maximising patient comfort, and therapeutic outcomes
- 1 in 3 cell alternation cycle with 24 narrow profile cells
- Focused heel care – removable heel cells facilitate rapid response to changes in heel therapy needs
- Dual compressor pump – reduces noise and efficiently manages patient therapy at highest patient weight loads (250kg)
- Hospital grade cover – thicker weight polyurethane fabric with increased bleach resistance to handle modern hospital infection control standards. Suitable for sodium hydrochloride solutions

Code	PTM639400T - Single	PTM639410T - King Single
Overall Length	2000mm	2000mm
Overall Width	900mm	1050mm
Overall Height	200mm	200mm
Number of Cells	24 (incl 3x static head cells)	24 (incl 3x static head cells)
Effective Weight Range	30 - 250kg	
Pump	Digital	Digital

## Hybrid Comfort

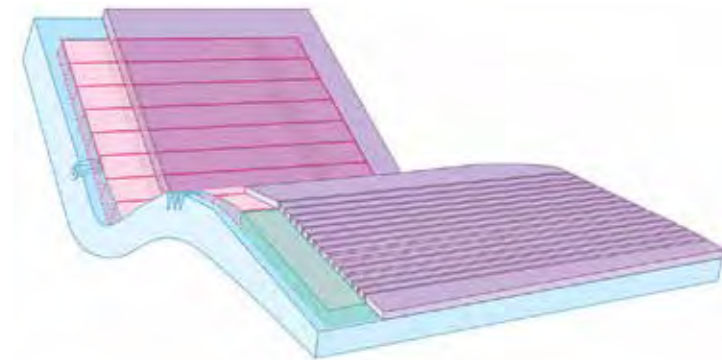

### APPLICATIONS

- Hospital
- Age Care
- Community
- Non-ambulant Patients
- Ambulant Patients



- Immersive visco-elastic memory foam surface: top layer is now twice as thick to offer significant improvement in user comfort
- Intelligent hose management: when not in use the air-hose can be stored internally, reducing infection control and OH&S risks
- Integrated shear reduction: memory foam layer moves independently of the cell surface reducing shear when bed is adjusted
- Optimised heel protection: tapered heel zone redistributes pressure to lower leg, away from the vulnerable heel region
- Innovative pump technology: reduces noise and vibration for undisturbed sleep

### OPTIONAL ACCESSORIES

- Digital Pump (PTM638030)

Code	PTM638005 - Single	PTM638006 - King Single	PTM638027 - BARI
Overall Length	1980mm	1980mm	1980mm
Overall Width	895mm	1050mm	1050mm
Overall Height	170mm	170mm	170mm
Effective Weight Range	30 - 230kg	30 - 230kg	150 - 380kg
Digital Pump	PTM638030		PTM638032

EFFECTIVE WEIGHT RANGE: **30-230KG**

**5 YEARS WARRANTY**  
Pump & Cover

**5 YEARS WARRANTY**  
Foam

ARTG - 291660



## Active Air® BARI 10



EFFECTIVE WEIGHT RANGE: **30-450KG**

**2 YEARS WARRANTY**  
Pump

**2 YEARS WARRANTY**  
Replacement

ARTG - 293518

- Integrated turning therapy - allows patient rotation up to 40° for improved pressure care and to assist staff with patient handling
- Rapid pump inflation - maximises therapy response times and minimises staff resources by fully inflating in only 2x minutes
- Hospital grade cover – thicker weight polyurethane fabric with increased bleach resistance to handle modern hospital infection control standards. Suitable for sodium hydrochloride solutions
- Adaptable pump - it can be switched between modes for typical users (up to 160kg) and bariatric users (up to 450kg) ensuring a single asset can meet the broadest spectrum of patient needs

Code	PTM639500 - Single	PTM639510 - King Single	PTM639520 - Super King Single
Overall Length	2000mm	2000mm	2000mm
Overall Width	900mm	1070mm	1230mm
Overall Height	270mm	270mm	270mm
Number of Cells	20	20	20
Effective Weight Range	30 - 450kg		
Pump	Digital	Digital	Digital

# Patient Trolleys

---

Aidacare's range of patient trolleys are designed to make transporting patients quick and easy.

Our medical patient trolleys are ideal for hospitals. They can be used to transfer patients between rooms and wards, in and out of surgical suites, and more. All of our patient transport trolleys feature a durable construction that allows them to withstand the daily rigours of hospital use. Our selection features high-quality options from reputable brands.





They are also designed for optimal comfort, safety and hygiene. As well as making transfers gentler on patients, our trolleys can reduce the risk of strain and injury to staff caused by manual handling.



## ONEday Electric Hospital Patient Trolley



### OPTIONAL ACCESSORIES

-  Static Mattress with Extension Bolster (BEM050300)
-  IV Pole (TSE674130)
-  Oxygen Bottle Holder (TSE674110)
-  Folding Monitor Tray (TSE674120)



Electric Trendelenburg and Reverse-Trendelenburg functions



**BIOCOTE**  
Antibacterial frame coating for improved infection control



**2 YEARS WARRANTY**

### Features and Benefits

- 4-section fully electric patient trolley offering the functions of a bed with the smaller footprint and mobility of a stretcher
- Electric Trendelenburg and reverse-Trendelenburg functions
- 200mm castors minimise rolling resistance
- Fifth central wheel improves steering and reduces manual handling burden in transportation
- 260kg SWL and inbuilt leg extension facilitate changing patient and clinical needs across multiple ward requirements
- Hand control flexible arm for patient independence and comfort
- Enhanced battery-pack, with day-long operating time, dedicated battery charger for a full and fast recharge
- Audible alarm system sounds when mains power is lost and when brakes are unlocked
- Quick Release CPR for back rest and knee break ensures the patient trolley is emergency ready at all times
- Frame is finished with Biocote, a technologically advanced surface coating that promotes infection control via its antibacterial properties



<b>Code</b>	TSE674100
<b>Overall Length</b>	1990 - 2170mm
<b>Overall Width</b>	890mm
<b>Overall Height</b>	400 - 830mm
<b>Patient Surface Length</b>	1880 - 2060mm
<b>Patient Surface Width</b>	710mm
<b>Backrest Angle</b>	0° - 70°
<b>Knee Bend Angle</b>	0° - 30°
<b>Trendelenburg</b>	-17° - 17°
<b>Castor Size</b>	200mm
<b>SWL</b>	260kg

ARTG - 295859

## Brera RX Patient Trolley



### OPTIONAL ACCESSORIES

-  IV Pole (TSE674130)
-  Oxygen Bottle Holder (TSE674110)
-  Folding Monitor Tray (TSE674120)



**BIOCOTE**  
Antibacterial frame coating for improved infection control



**2 YEARS WARRANTY**

### Features and Benefits:

- Foot operated hydraulic lift, tilt, back raise, Trendelenburg and reverse Trendelenburg functions
- Full length sliding X-ray deck ensures complete spinal coverage
- Comfortable 100mm foam mattress with multi-stretch cover
- Quick Release CPR with access from both sides for backrest and knee break ensures the stretcher is emergency ready at all times
- Collapsible vertical side rails fold away below the patient surface
- Fold-away carer push handles to maximise workspace
- 200mm castors minimise rolling resistance with central and directional locking functions
- Molded base cover facilitates cleaning and supports infection control processes
- Large corner bumpers minimise wear and tear on equipment and facilities
- Frame is finished with Biocote, a technologically advanced surface coating that promotes infection control via its antibacterial properties

<b>Code</b>	TSE674300
<b>Overall Length</b>	2100mm
<b>Overall Width</b>	830mm
<b>Overall Height</b>	560 - 880mm
<b>Patient Surface Length</b>	2000mm
<b>Patient Surface Width</b>	650mm
<b>Backrest Angle</b>	0° - 90°
<b>Trendelenburg</b>	-17° - 17°
<b>Castor Size</b>	200mm
<b>SWL</b>	270kg

ARTG - 295859

# Elektra Hospital Patient Trolley with Electric Drive Wheel



### OPTIONAL ACCESSORIES

- IV Pole (TSE674130)
- Oxygen Bottle Holder (TSE674110)
- Folding Monitor Tray (TSE674120)



**BIOCOTE**  
Antibacterial frame coating for improved infection control



### Features and Benefits:

- Foot operated hydraulic lift, tilt, back raise, Trendelenburg, and reverse Trendelenburg functions
- Full length sliding X-ray deck ensures complete spinal coverage
- DeltaDrive electric centre 5th wheel with integrated controls in headboard provides increased maneuverability for hospital staff
- Comfortable 100mm foam mattress with multi-stretch cover
- Quick Release CPR with access from both sides for backrest and knee break ensures the stretcher is emergency ready at all times
- Collapsible vertical side rails fold away below the patient surface
- Fold-away carer push handles to maximise workspace
- 200mm castors minimise rolling resistance with central and directional locking functions
- Molded base cover facilitates cleaning and supports infection control processes
- Large corner bumpers minimise wear and tear on equipment and facilities
- Frame is finished with Biocote, a technologically advanced surface coating that promotes infection control via its antibacterial properties

<b>Code</b>	TSE674310
<b>Overall Length</b>	2270mm
<b>Overall Width</b>	830mm
<b>Overall Height</b>	580 - 860mm
<b>Patient Surface Length</b>	2000mm
<b>Patient Surface Width</b>	650mm
<b>Backrest Angle</b>	0° to 90°
<b>Trendelenburg</b>	-16° to 16°
<b>Castor Size</b>	200mm
<b>SWL</b>	270kg

ARTG - 295859

# Advanced Electric Patient Trolley



### STANDARD INCLUSIONS

- IV Pole
- Oxygen Bottle Holder

### OPTIONAL

- Defibrillator Table (TSE674240)

### Features and Benefits

- Electrically adjustable height and positioning
- Radiolucent platform with electronic adjustment for full body X-ray imaging
- Wipe clean surfaces for infection control procedures
- 200mm Tente castors with central locking levers for optimal durability, traction, and safety
- Ergonomic grip handles and fifth centre wheel, enhance manoeuvrability and steering
- Fold down side rails for safety and ease of transfers
- 100mm mattress helps to prevent shear and promote optimal skin microclimate
- Integrated patient safety straps for peace of mind



<b>Code</b>	TSE674230
<b>Overall Length</b>	2140mm
<b>Overall Width</b>	840mm
<b>Overall Height</b>	610 - 900mm
<b>Patient Surface Length</b>	1920mm
<b>Patient Surface Width</b>	600mm
<b>Backrest Angle</b>	0° to 70°
<b>Trendelenburg</b>	-12° to 12°
<b>Castor Size</b>	200mm
<b>SWL</b>	225kg

ARTG - 298918

# Electric Mobile Shower Trolley



### Features and Benefits

- Epoxy powder coated and ergonomic push handle
- Liner can be secured in the corners to facilitate in bath
- Padded vinyl mattress and corner buffer discs
- Large screw in flexible waste hose (ø 60mm)
- Lightweight swing under side rails
- Electric Trendelenburg/tilt 8° degrees
- Electric high-low operation 600-1000mm
- Curved base construction allows access for carers
- 125mm total lock and directional castors
- Plug-in rechargeable battery pack
- Stainless steel and PVC top



<b>Code</b>	BTS147100 - Standard	BTS147128 - Wide long
<b>Overall Length</b>	1890mm	2000mm
<b>Overall Width</b>	730mm	900mm
<b>Overall Height</b>	600mm - 1000mm	600 - 1000mm
<b>SWL</b>	150kg	200kg

ARTG - 229005

# Patient Hygiene

---

Maintaining good patient hygiene is not only essential for recovery and to avoid infection, it also helps to maintain patient dignity and comfort.

Many bathroom tasks, such as using the toilet and showering, can be challenging for unwell, injured, or mobility-impaired patients. It can also be strenuous and potentially dangerous for the staff who need to assist them.

At Aidacare, we provide a range of patient hygiene aids that are ideal for hospitals and clinical facilities. Designed to provide support and assistance to both patients and carers, our aids can help ensure safety and comfort for both parties.

The Aidacare selection of patient hygiene aids includes shower chair and stools, shower commodes, shower trolleys, toileting aids, over toilet aids, and toilet surrounds.



## Weight Bearing Platform Commode - 460mm



- Easy-slide weight bearing platform footrest slides away for transfers
- 8° backrest angle
- Improved over toilet clearance
- Integrated access trough improves hygiene whilst maintaining toilet bowl clearance height of 465mm
- 4x TENTE total locking castors, brake access from all angles
- Safety arms prevent falls, swing out for transfers
- Open armrests style for a wider sitting surface, with a smaller base footprint for improved accessibility

### OPTIONAL



Self propelled option: Anti-tippers and 2x rear lockable self propelling wheels with brakes

Code	BTC066000 - Attendant Propelled	BTC066200 - Self Propelled
Overall Height	995mm	995mm
Overall Width	535mm	665mm
Seat Width	460mm	530mm
Backrest Height	305mm	305mm
Armrest Height	225mm	225mm
Anterior Seat	590mm	590mm
Posterior Seat	560mm	560mm
SWL	200kg	200kg

**SWL 200kg**

**5 YEARS WARRANTY Corrosion**

**1 YEAR WARRANTY Components**

ARTG - 286695

## Swing Away Legrest Commode - 460mm



- Angle adjustable backrest from 8° to 18° for seating comfort
- Ultra low seat height of 590mm, can be customised to 490mm
- Improved over toilet clearance
- Integrated access trough improves hygiene whilst maintaining toilet bowl clearance height of 465mm
- 4x TENTE total locking castors, brake access from all angles
- Safety arms prevent falls, swing out for transfers
- Open armrests style for a wider sitting surface, with a smaller base footprint for improved accessibility

### OPTIONAL



Self propelled option: Anti-tippers and 2x rear lockable self propelling wheels with brakes

Code	BTC065900 - Attendant Propelled	BTC066100 - Self Propelled
Overall Height	895-995mm	895-995mm
Overall Width	535mm	665mm
Seat Width	460mm	460mm
Backrest Height	305mm	305mm
Armrest Height	225mm	225mm
Anterior Seat	590mm	590mm
Posterior Seat	560mm	560mm
SWL	200kg	200kg

**SWL 200kg**

**5 YEARS WARRANTY Corrosion**

**1 YEAR WARRANTY Components**

ARTG - 286695

## Weight Bearing Platform Commode - 530mm



- Easy-slide weight bearing platform footrest slides away for transfers
- 8° backrest angle
- Improved over toilet clearance
- Integrated access trough improves hygiene whilst maintaining toilet bowl clearance height of 465mm
- 4x TENTE total locking castors, brake access from all angles
- Safety arms prevent falls, swing out for transfers
- Open armrests style for a wider sitting surface, with a smaller base footprint for improved accessibility

### OPTIONAL



Self propelled option: Anti-tippers and 2x rear lockable self propelling wheels with brakes

Code	BTC066050 - Attendant Propelled	BTC066055 - Self Propelled
Overall Height	995mm	995mm
Overall Width	605mm	735mm
Seat Width	530mm	530mm
Backrest Height	305mm	305mm
Armrest Height	225mm	225mm
Anterior Seat	590mm	590mm
Posterior Seat	560mm	560mm
SWL	200kg	200kg

**SWL 200kg**

**5 YEARS WARRANTY Corrosion**

**1 YEAR WARRANTY Components**

ARTG - 286695

## Swing Away Footrest Commode - 530mm



- Height adjustable, swing away footrests
- Angle adjustable backrest from 8° to 18° for seating comfort
- Ultra low seat height of 590mm, can be customised to 490mm
- Improved over toilet clearance
- Integrated access trough improves hygiene whilst maintaining toilet bowl clearance height of 465mm
- 4x TENTE total locking castors, brake access from all angles
- Safety arms prevent falls, swing out for transfers
- Open armrests style for a wider sitting surface, with a smaller base footprint for improved accessibility

### OPTIONAL



Self propelled option: Anti-tippers and 2x rear lockable self propelling wheels with brakes

Code	BTC066060 - Attendant Propelled	BTC066065 - Self Propelled
Overall Height	995mm	995mm
Overall Width	605mm	735mm
Seat Width	530mm	530mm
Backrest Height	305mm	305mm
Armrest Height	225mm	225mm
Anterior Seat	590mm	590mm
Posterior Seat	560mm	560mm
SWL	200kg	200kg

**SWL 200kg**

**5 YEARS WARRANTY Corrosion**

**1 YEAR WARRANTY Components**

ARTG - 286695

## Bariatric Weight Bearing Platform Commode - 600mm



- Heavy duty reinforced wide frame can support bariatric users up to 400kg
- Easy-slide weight bearing platform footrest slides away for transfers
- 4x total locking stainless steel castors, brake access from all angles
- Height adjustable reinforced armrests offer drop flat positioning to assist with lateral slide transfers

Code	BTC061400 (Attendant Propelled)
Overall Height	995mm
Overall Width	725mm
Seat Width	600mm
Backrest Height	300mm
Armrest Height	290mm
Anterior Seat	590mm
Posterior Seat	560mm
SWL	400kg

**SWL 400kg**

**5 YEARS WARRANTY Corrosion**

**1 YEAR WARRANTY Components**

**BIARIATIC**

ARTG - 286695

## Swing Away Footrest Commode - 600mm



- Height adjustable, swing away footrests
- Ultra low seat height of 590mm, can be customised to 490mm
- Angle adjustable backrest from 8° to 18° for seating comfort
- Integrated access trough improves hygiene whilst maintaining toilet bowl clearance height of 465mm
- Safety arms prevent falls, swing out for transfers
- Open armrests style for a wider sitting surface whilst maintaining a smaller base footprint for improved accessibility
- 4x TENTE total locking castors, brake access from all angles

### OPTIONAL



Self propelled option: Anti-tippers for maximum safety and 2x rear lockable self propelling wheels

Code	BTC061300 (Attendant Propelled)	BTC061305 (Self Propelled)
Overall Height	995mm	995mm
Overall Width	675mm	805mm
Seat Width	600mm	600mm
Backrest Height	305mm	305mm
Armrest Height	225mm	225mm
Anterior Seat	590mm	590mm
Posterior Seat	560mm	560mm
SWL	200kg	200kg

**SWL 200kg**

**5 YEARS WARRANTY Corrosion**

**1 YEAR WARRANTY Components**

ARTG - 286695

## Tilt & Recline Shower Commode



- 30° backrest angle adjustment in 10° increments for effortless repositioning and maximum user comfort
- -5° to 35° gas-assisted tilt-in-space functionality minimises manual handling efforts
- Backrest may be configured as full length or 3/4 length to accommodate an advanced headrest
- Open back straps provide access for bathing
- Safety arms prevent falls and swing back out of the way for transfers
- Open back straps provide access for bathing



30° backrest angle adjustment in 10° increments



-5° to 35° tilt-in-space functionality

Code	BTC066030	BTC066040
Overall Height	1315mm - 1485mm	1315mm - 1485mm
Overall Width	560mm	630mm
Seat Width	460mm	530mm
Backrest Height	900mm	900mm
Armrest Height	275mm	275mm
Anterior Seat Height	460mm - 630mm	460mm - 630mm
Posterior Seat Height	460mm - 620mm	460mm - 620mm
SWL	200kg	200kg



5 YEARS WARRANTY  
Corrosion

1 YEAR WARRANTY  
Components

ARTG - 286695

## Bariatric Shower Commode



- Super heavy duty bariatric design with 790mm seat and 350kg SWL
- Padded seat and arms for maximum comfort
- Removable arms to assist with positioning and allow lateral slide transfers
- 4x lockable castors maximise safety by providing carer access to a brake at all angles around the commode
- Height adjustable, swing away footrests for optimal positioning and ease of transfers



790mm seat and 350kg SWL



Padded seat and arms

Code	BTC061200
Overall Height	990mm
Overall Width	900mm
Seat Width	790mm
Backrest Height	430mm
Armrest Height	170mm
Anterior Seat	570mm
Posterior Seat	570mm
SWL	350kg



5 YEARS WARRANTY  
Corrosion

1 YEAR WARRANTY  
Components

ARTG - 286695

## Shower Commode Seats

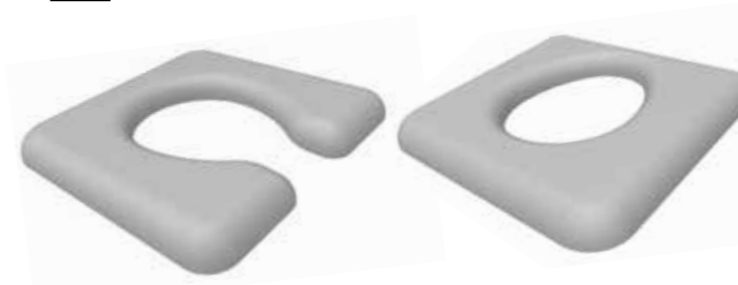

Open Seat - 460mm	BTC066600
Closed Seat - 460mm	BTC066700
Open Seat - 530mm	BTC066750
Open Seat - 600mm	BTC066800

1 YEAR WARRANTY

ARTG - 286695

- Moulded and seamless soft PU seats designed for comfort and durability
- Easy clean, fully sealed surface for infection control
- Choose the size appropriately to fit your Aspire Shower Commode
- Adaptable to most shower commode brands
- M6 Tri Nut assembly kit needed for seat attachment. Comes as standard with all commodes. Available as a spare part if lost (GSP342405)

## Hand Made Pressure Reducing Shower Commode Seats



Open Front - 320mm	BTC089122
Closed Front - 320mm	BTC089124
Open Front - 400mm	BTC089126
Closed Front - 400mm	BTC089128
Open Front - 460mm	BTC089130
Closed Front - 460mm	BTC089140
Open Left - 460mm	BTC089150
Open Right - 460mm	BTC089160
Custom Option	BTC089250

Open Front - 500mm	BTC089170
Closed Front - 500mm	BTC089180
Open Front - 550mm	BTC089190
Closed Front - 550mm	BTC089200
Open Front - 600mm	BTC089210
Closed Front - 600mm	BTC089220
Open Front - 650mm	BTC089230
Closed Front - 650mm	BTC089240

1 YEAR WARRANTY

ARTG - 286695

## Shower Commode Accessories



1. Self Propelling Conversion Kit  
ARTG - 286695

2. Elevating Leg Rest  
ARTG - 286695

3. Commode Bowl & Pan  
ARTG - 230171

4. Pan Carrier  
ARTG - 286695

5. Oxygen Bottle Carrier  
ARTG - 286695

6. Adjustable IV Pole  
ARTG - 286695

7. Adjustable Pelvis Belt  
ARTG - 286695

8. Advanced Headrest  
ARTG - 286695

9. Stump Support  
ARTG - 286695

10. Lateral Support  
ARTG - 286695

	Code	Product
1	BTC082900	Self Propelling Conversion Kit
2	BTC067108M	Elevating Legrests - Left - Swing Away Commodes Only
	BTC067109M	Elevating Legrests - Right - Swing Away Commodes Only
	BTC067110M	Elevating Legrests - Left - Tilt & Recline Commodes Only
	BTC067115M	Elevating Legrests - Right - Tilt & Recline Commodes Only
3	BTC081610	Commode Bowl with Lid & Handle
	BTT151800	Bed Pan

	Code	Product
4	BTC066400	Pan Carrier
5	BTC067200	Oxygen Bottle Carrier
6	BTC067103	Adjustable IV Pole
7	BTC067100	Adjustable Pelvic Belt
8	BTC067050	Advanced Headrest
9	BTC067105	Stump Support
10	WCA867010	Lateral Support



## Verto Electric Height Adjustable Tilt in Space



- Robust, lightweight design with removable and height adjustable polyurethane backrest and height adjustable padded headrest
- Ergonomic release handle for high/low adjustment
- 125mm anti-static total lock maintenance free castors, epoxy powder coated stainless steel frame and removable battery
- Clip on seat can be easily removed for cleaning
- Padded swing back armrests and swing away, height adjustable footrests with padded calf supports



Code	BTC069502	BTC069505	BTC069507
Overall Width	670mm	700mm	700mm
Backrest Height	520mm	630mm	630mm
Seat Height	530mm	590mm	590mm
Seat Width	470mm	600mm	700mm
Tilt Angle	30°	10-30°	10-35°
SWL	150kg	250kg	250kg

## Verto Shower Commode Seat Options



Code	Product
BTC069520	Polyurethane - Closed Front - 470mm
BTC069510*	Polyurethane - Open Front - 470mm

Code	Product
BTC089131	Pressure Reducing Seat - Open -Width 460mm
BTC089130*	Pressure Reducing Seat - Closed -Width 460mm

Code	Product
BTC069525	Shower Commode Seat - Open Front w/ Pan Carrier Runners - 550mm
BTC069530	Shower Commode Seat - Open Front w/ Pan Carrier Runners - 550mm

All seats above are compatible with the Verto Shower Commode Range

## MAXI Shower Chair



- Super heavy duty adjustable width shower chair
- Soft padded seat, back, and arms provide postural support
- Reinforced aluminium frame accommodates bariatric users and is corrosion resistant
- Height adjustable legs with easy circlip adjustment points
- Raised armrests to assist the user in transferring on and off the chair
- Durable non-slip feet provide excellent grip and stability in wet conditions. Stainless steel washer enhances durability



Super heavy duty width adjustable frame  
Up to 775mm wide

Code	BTS118020
Overall Height	670 - 1005mm
Overall Width	645 - 845mm
Overall Depth	495mm
Seat Height	455 - 575mm
Sitting Width	575 - 775mm
Seat Depth	455mm
SWL	310kg



ARTG - 306118

## MAXI Shower Stool



- Super heavy duty adjustable width shower stool
- Soft padded seat and arms provide postural support
- Reinforced aluminium frame accommodates bariatric users and is corrosion resistant
- Height adjustable legs with easy circlip adjustment points
- Raised armrests to assist the user in transferring on and off the over toilet aid seat
- Durable non-slip feet provide excellent grip and stability in wet conditions. Stainless steel washer enhances durability



Super heavy duty width adjustable frame  
Up to 775mm wide

Code	BTS119030
Overall Height	670 - 790mm
Overall Width	645 - 845mm
Overall Depth	495mm
Seat Height	455 - 575mm
Sitting Width	575 - 775mm
Seat Depth	455mm
SWL	310kg



ARTG - 306118

## MAXI Over Toilet Aid



- Super heavy duty adjustable width over toilet aid
- Reinforced aluminium frame accommodates bariatric users and is corrosion resistant
- Height adjustable legs with easy circlip adjustment points
- Raised armrests to assist the user in transferring on and off the stool
- Durable non-slip feet provide excellent grip and stability in wet conditions. Stainless steel washer enhances durability



Soft padded flip up seat for easy cleaning  
Up to 775mm wide

Code	BTT145020
Overall Height	670 - 790mm
Overall Width	645 - 845mm
Overall Depth	495mm
Seat Height	455 - 575mm
Sitting Width	575 - 775mm
Seat Depth	455mm
SWL	310kg



ARTG - 306118

## Shower Chair



- Contoured plastic seat with drainage holes
- Height adjustable legs and raised armrests for assisted user transfer
- Frames individually treated for corrosion resistance
- Non-slip grip and stability in wet conditions
- Stainless steel washer within enhances durability
- Heavy duty, reinforced frame accommodates very high SWL

Code	Regular BTS118000 - Steel, BTS118005 - Alum.	Wide BTS118010 - Steel BTS118015 - Alum.
Overall Height	735 - 910mm	735 - 910mm
Overall Width	512mm	570mm
Overall Depth	570mm	570mm
Seat Height	375 - 550mm	375 - 550mm
Seat Width	440mm	440mm
Seat Depth	400mm	400mm
Width Between Arms	470mm	525mm
SWL	200kg	200kg



Steel ARTG - 230166 | Aluminum ARTG - 230167



## Shower Stool

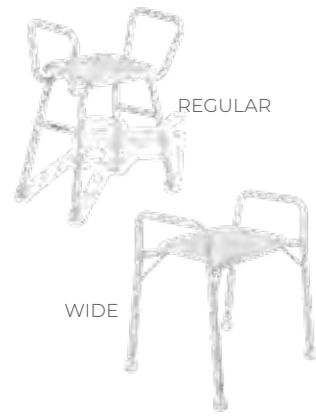

- Clip on seat or padded back attachment – For easy assembly and cleaning
- Height adjustable legs – Easy push button height adjustment for changing needs
- All frames are individually treated for corrosion resistance

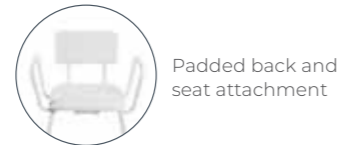

Code	Regular BTS119000 - Steel BTS119005 - Alum	Wide BTS119010 - Steel BTS119015 - Alum.
Overall Height	670 - 855mm	575 - 765mm
Overall Width	545mm	570mm
Overall Depth	400mm	500mm
Seat Height	470 - 655mm	425 - 615mm
Seat Width	375mm	420mm
Seat Depth	310mm	365mm
Width Between Arms	495mm	525mm
SWL	175kg	175kg
With Padded Attachments	BTS119020 - Regular Steel + Seat BTS119025 - Regular Steel + Seat & Back	

**SWL 175kg**

**5 YEARS WARRANTY**  
Corrosion

**1 YEAR WARRANTY**  
Structure

Steel ARTG - 230166 | Aluminum ARTG - 230167

## Over Toilet Aid



- Raised armrests assist the user transferring on and off
- Comfortable, contoured seat with clip on attachment height adjustable legs
- Frames individually treated for corrosion resistance
- Removable, moulded splash guard provided
- Durable non-slip feet for grip and stability in wet conditions and a stainless steel washer within enhances durability

### OPTIONAL

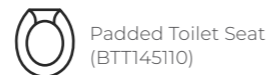

Code	Regular BTT145000 - Steel BTT145005 - Alum	Wide BTT145010 - Steel BTT145015 - Alum
Overall Height	700 - 880mm	700 - 880mm
Overall Width	512mm	570mm
Overall Depth	625mm	625mm
Seat Height	450 - 630mm	450 - 630mm
Seat Width	370mm	370mm
Seat Depth	435mm	435mm
Width Between Arms	460mm	525mm
SWL	175kg	175kg

**SWL 175kg**

**5 YEARS WARRANTY**  
Corrosion

**1 YEAR WARRANTY**  
Structure

Steel ARTG - 230170 | Aluminum ARTG - 230169

## Toilet Surround Frame



- Height adjustable frame with easy push button height adjustment
- Raised armrests assist the user transferring on and off the toilet
- Durable non-slip feet provide excellent grip and stability in wet conditions and a stainless steel washer within enhances durability
- Additional height increments on one leg – accommodates uneven surfaces

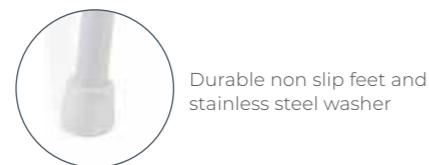

Code	BTT155100
Overall Height	535 - 660mm
Overall Width	500mm
Overall Depth	435mm
Between Arms	450mm
Unit Weight	3kg
SWL	175kg

**SWL 175kg**

**5 YEARS WARRANTY**  
Corrosion

**1 YEAR WARRANTY**  
Structure

ARTG - 230170

## Raised Toilet Seat



- Three heights available – helps facilitate sit-to-stand transfers
- Contoured plastic seat – comfortable and durable
- Fully sealed structure – easy to clean for increased infection control
- Generous cut outs at the front and rear for personal care and hygiene
- Two adjustable mounting brackets – provide an adjustable, secure fit

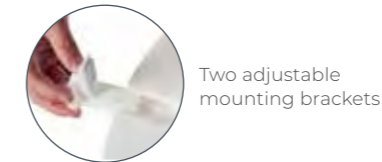

**SWL 200kg**

**5 YEARS WARRANTY**  
Corrosion

**1 YEAR WARRANTY**  
Structure

ARTG - 242921

### OPTIONAL



Available with or without lid

No Lid - Code	BTT149800 - 50mm BTT150200 - 100mm BTT150300 - 150mm
With Lid - Code	BTT149900 - 50mm BTT150100 - 100mm BTT150400 - 150mm
Overall Height	2" (50 mm) 4" (100 mm) 6" (150 mm)
Unit Weight	1.4kg
SWL	200kg

## Urinal and Bed Pans



1. Spill Proof Urinal    2. Male Urinal With Lid    3. Male Urinal    4. Male Urinal With Screw Lid    5. Female Urinal Cygnet

6. Female Urinal    7. Bed Pan ARTG - 230087    8. Bed Pan Slipper    9. Urinal Bottle Holder    10. Commode Bowl ARTG - 230171

	Code	Product
1	BTT148200	Spill Proof Male Urinal
2	BTT148450	Male Urinal with Lid
3	BTT145700	Male Urinal - Green
4	BTT160900	Male Urinal - Clear
5	BTT148400	Male Urinal with Screw Lid
6	BTT148800	Female Urinal Cygnet
7	BTT148700	Female Urinal
8	BTT151800	Bed Pan
9	BTT148000	Bed Pan Slipper - Small
10	BTT161500	Bed Pan Slipper - Large
9	BTT149000	Urinal Bottle Holder
10	BTC081610	Commode Bowl with Lid and Handle

# Patient Transport and Mobility

---

In demanding hospital and medical environments, robust and durable wheelchairs are essential. Designed to help transfer those who are unable to walk, a wheelchair is useful for patients entering and exiting the hospital, as well as those who need to be moved between rooms, wards, and areas.

Aidacare offers a range of high-quality wheelchairs that can be used to transfer patients safely and comfortably. Our selection of wheelchairs includes a variety of manual options as well as sturdy bariatric choices. We also offer foldable styles, which are ideal for easy storage when not in use. Suitable for hospitals and medical facilities, our wheelchairs are easy to push and manoeuvre. They are available in various sizes and designs to cater to different requirements.

# Assist 2 - WARD Vinyl



**OPTIONAL**  
Frame Fix Mod (AAL848590)

**OPTIONAL ACCESSORIES**  
Refer to Wheelchair Accessories Matrix on pages 52-53 to see the range



Swing-away removable legrests



**SWL 140kg**

**HD SWL 180kg**

**2 YEARS WARRANTY**  
Frame

**1 YEAR WARRANTY**  
Components

<b>Code</b>	MWS449340 - 350mm (14")
	MWS449350 - 400mm (16")
	MWS449360 - 450mm (18")
	MWS449370 - 500mm (20")
	MWS449380 - HD - 570mm (22")
	MWS449390 - HD - 610mm (24")
<b>Seat Width</b>	350 - 610mm
<b>Seat Depth</b>	400mm
<b>Seat Height</b>	460 - 500mm
<b>SWL</b>	140kg
<b>HD SWL</b>	180kg

ARTG - 291670

# Assist 2 - Everyday



- Folding steel frame
- Swing-away, removable height adjustable footrests
- Swing-back, removable armrests
- Quick release, solid 24" tyres
- Push-to-lock brakes
- 8" height adjustable castors
- Dacron fire retardant fabric

**OPTIONAL ACCESSORIES**  
Refer to Wheelchair Accessories Matrix on pages 52-53 to see the range



Swing-away removable legrests



Push-to-lock brakes

**SWL 140kg**

**2 YEARS WARRANTY**  
Frame

**1 YEAR WARRANTY**  
Components

ARTG - 291670

<b>Seat Width</b>	350 - 500mm
<b>Seat Depth</b>	400mm
<b>Seat Height</b>	460 - 500mm
<b>SWL</b>	140kg
<b>Code</b>	MWS449300 - 350mm (14")
	MWS449310 - 400mm (16")
	MWS449320 - 450mm (18")
	MWS449330 - 500mm (20")

# Evoke 2 - Lightweight & Highly Adjustable



- Highly adjustable lightweight folding wheelchair
- Swing-away and removable legrests
- Height and angle adjustable footrests
- Quick release, solid 24" tyres, height and depth adjustable
- 8" height and angle adjustable castors
- Easy access push-to-lock brakes
- Depth and height adjustable seat
- Height, tension, angle and depth adjustable backrest
- Dacron fire retardant fabric
- Standard cushion included

**OPTIONAL**  
Contoured Padded Overlay  
(Refer to Wheelchair Accessories Matrix on pages 52-53)

**SWL 150kg**

**HD SWL 190kg**

**2 YEARS WARRANTY**  
Frame

**1 YEAR WARRANTY**  
Components

ARTG - 291670

<b>Code</b>	MWS449500 - 350mm (14")
	MWS449510 - 400mm (16")
	MWS449520 - 450mm (18")
	MWS449530 - 500mm (20")
	MWS449540 - HD - 570mm (22")
	MWS449550 - HD - 610mm (24")
<b>Seat Width</b>	350 - 610mm
<b>Seat Depth</b>	400 - 475mm
<b>Seat Height</b>	440 - 480mm
<b>SWL</b>	150kg
<b>HD SWL</b>	190kg



## Evoke 2 - Junior



- Highly adjustable lightweight paediatric folding wheelchair
- Swing-away and removable legrests
- Height and angle adjustable footrests
- Height adjustable and removable armrests
- Quick release, solid 20" tyres
- Easy access push-to-lock brakes
- Height and depth adjustable seat
- Height, angle, and depth adjustable backrest



Swing-away removable legrests



8" height and angle adjustable castors

<b>Code</b>	MWS449560
<b>Seat Width</b>	300mm
<b>Seat Depth</b>	300 - 375mm
<b>Seat Height</b>	360 - 410mm
<b>SWL</b>	140kg



**2 YEARS WARRANTY**  
Frame

**1 YEAR WARRANTY**  
Components

ARTG - 291670



## Rehab RX - Advanced Tilt-In-Space



- Highly configurable, for complex needs in rehab environment
- Elevating legrests
- Quick release, solid 24" tyres, height and depth adjustable
- Attendant operated drum brakes, push-to-lock handbrakes
- Adjustable backrest, armrests, footrests, and headrest
- Breathable PU multi-stretch fabric covers for pressure redistribution
- Multilayer castellated back and seat cushions with gentle lumbar build up and lateral supports
- 6" castors



Swing-away, removable, padded, and elevating legrests



Multilayer castellated back and seat cushions

<b>Rehab RX Advanced</b>	MWS449710 - 410 - 460mm (16 - 18")
	MWS449720 - 460 - 510mm (18 - 20")
	MWS449740 - 510 - 560mm (20 - 22")
<b>Seat Width</b>	410 - 560mm
<b>Seat Depth</b>	440 - 560mm
<b>Seat Height</b>	400 - 475mm
<b>SWL</b>	180kg



**2 YEARS WARRANTY**  
Frame

**1 YEAR WARRANTY**  
Components

## Rehab RX JNR



- Highly configurable tilt-in-space chair for paediatric users in the rehab environment
- Elevating legrests
- Quick release, solid 20" tyres
- Height and angle adjustable legrest
- Attendant operated drum brakes and push-to-lock handbrakes
- Adjustable backrest, armrests, footrests, headrest
- 6" castors
- PU breathable multi-stretch fabric covers
- Multilayer castellated back and seat cushions with gentle lumbar build up and lateral supports



Multilayer castellated back & seat cushions

<b>Code</b>	MWS449630
<b>Seat Width</b>	320 - 370mm
<b>Seat Depth</b>	440 - 490mm
<b>Seat Height</b>	400 - 475mm
<b>SWL</b>	180kg



**2 YEARS WARRANTY**  
Frame

**1 YEAR WARRANTY**  
Components

ARTG - 291393



## Power Assist



- Easily attaches directly on to manual wheelchairs
- Features an easy-to-use squeeze trigger mechanism
- Comes with an easy-to-use controller with speed dial, battery indicator, and hand-controlled lever
- Customisable speed settings
- Range up to 16km between charges
- Dual-wheel design for added traction and stability
- Maximum speed of up to 5km/h

<b>Code</b>	Power Assist WCA858501	Power Assist HD WCA858511
<b>Suits</b>	Seat Widths 16" - 20"	Seat Widths 16" - 24"
<b>Max Speed</b>	5km/h	6.4km/h
<b>SWL</b>	120kg	182kg



ARTG - 291393

## Transit 2 - Transporter



- Folding steel frame
- Swing away and removable arm rests facilitate user transfers and also makes for easier transport and storage.
- Height adjustable, removable foot rests facilitate user transfers and allows for optimal positioning for the changing needs of the user
- Quick release 12" solid rear tyres - wheels are easily removed to reduce weight of the chair for transport and storage
- 8" height adjustable castors
- Dacron fire retardant fabric

### OPTIONAL ACCESSORIES

Refer to Wheelchair Accessories Matrix on pages 52-53



Attendant push-to-lock brakes

<b>Code</b>	MWS449410 - 400mm (16")
	MWS449420 - 450mm (18")
	MWS449430 - 500mm (20")
<b>Seat Width</b>	400 - 500mm
<b>Seat Depth</b>	400mm
<b>Seat Height</b>	460 - 500mm
<b>SWL</b>	140kg

SWL  
140kg

2 YEARS WARRANTY  
Frame

1 YEAR WARRANTY  
Components

ARTG - 291670

## Heavy Duty & Super Heavy Duty Wheelchair



- Reinforced wheelchair for bariatric users
- Extra wide seat widths and reinforced construction accommodates larger users
- Moulded composite mag wheels
- Swing-away detachable footrests and removable padded armrests
- Durable chrome-plated steel construction
- Vinyl wipe clean seating surfaces



Removable padded armrest

<b>Heavy Duty</b>	MWS442910 - 500mm (20") - 136kg
	MWS442911 - 550mm (22")
	MWS442912 - 600mm (24")
<b>Super Heavy Duty</b>	MWS442901 - 650mm (26")
	MWS442902 - 700mm (28")
<b>Description</b>	Heavy Duty      Super Heavy Duty
<b>Seat Width</b>	500 - 600mm      650 - 700mm
<b>Seat Depth</b>	400 - 450mm      500mm
<b>Seat Height</b>	500mm              500mm
<b>SWL</b>	204kg                318kg

SWL  
136kg

HD SWL  
204kg

SHD SWL  
318kg



3 YEARS WARRANTY

ARTG - 222040



## Aspire Wheelchairs Accessories

1. Contoured Padded Overlay



2. Depth & Height Adjustable Armrest



3. Gutter Armrest



4. Drum Brakes



5. Depth Extension



6. Therapist-Friendly Tool-Free Adjustment Kit



7. Meal Tray



8. Anti-Tip Bars



9. IV Pole



10. Safety Lap Belt



11. Extended Back Cane - Pair



12. Headrest Assembly - Deluxe Style



13. Calf Strap



14. Camber Kit



15. Elevating Legrest



16. Stump Support



17. Oxygen Bottle Holder



18. Brake Extension Lever



19. Lateral Support



Please refer to:  
Aspire Wheelchair  
Accessories Matrix  
on pages 52-53  
for compatibility

ARTG - 291670 | ARTG - 291393



# Aspire Wheelchairs Accessories Matrix



To see if the accessory is **compatible** or **available** with specific wheelchairs.

No.	Codes	Product Description	Suits					
Contoured Padded Overlays			Evoke 2	Evoke 2 JNR	Rehab RX JNR	Rehab RX	Assist 2	Transit 2
1	WCA848330	Contoured Padded Overlay - 350mm Wide	●				●	
	WCA848340	Contoured Padded Overlay - 400mm Wide	●				●	●
	WCA848350	Contoured Padded Overlay - 450mm Wide	●				●	●
	WCA848360	Contoured Padded Overlay - 500mm Wide	●				●	●
	WCA848370	Contoured Padded Overlay - 570mm Wide	●				●	
	WCA848380	Contoured Padded Overlay - 610mm Wide	●				●	
Depth and Height Adjustable Armrest								
2	WCA848390	Depth & Height Adjustable Armrest - Left	●					
	WCA848400	Depth & Height Adjustable Armrest - Right	●					
Gutter Armrest *								
3	WCA848410	Gutter Armrest Pad - Left	●					
	WCA848420	Gutter Armrest Pad - Right	●					
Drum Brakes								
4	WCA848510	Rear Wheels w/Drum Brakes Kit - 16in		●	●	●		
	WCA848520	Rear Wheels w/Drum Brakes Kit - 20in		●	○	●		
	WCA848500	Rear Wheels w/Drum Brakes Kit - 24in	●			○		
Depth Extensions								
5	WCA848530	Base Frame Extension Kit - 50mm - Black				●		
	WCA848540	Base Frame Extension Kit - 100mm - Black				●		
Other								
6	WCA848550	Therapist-Friendly Tool-Free Adjustment Kit			●	●		
7	WCA848560	Meal Tray - 320mm to 410mm			●	●		
	WCA848570	Meal Tray - 460mm to 510mm				●		
8	WCA848270	Anti-Tip Bars	●	●	○	○	●	●
9	WCA848280	IV Pole	●	●	●	●	●	●
10	WCA848300	Safety Lap Belt - Metal Seatbelt Buckle	●	●	●	●	●	●
11	WCA848470	Extended Back Cane - Pair - 19/21in	●	●				
12	WCA848480	Headrest Assembly - Deluxe Style	●	●				
13	WCA848580	Calf Strap	●	●	●	●	●	●
14	WCA848490	Camber Kit	●	●				
-	AAL848590	Security Mod - ASSIST 2 WARD Only					●	

ARTG - 291670 | ARTG - 291393

**KEY**

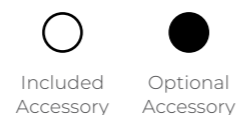

\*Note: Side transfers are not possible when gutter armrests are attached

# Aspire Wheelchairs Accessories Matrix



To see if the accessory is **compatible** or **available** with specific wheelchairs.

No.	Codes	Product Description	Suits					
Elevating Legrest			Evoke 2	Evoke 2 JNR	Rehab RX JNR	Rehab RX	Assist 2	Transit 2
15	WCA848100	Elevating Legrest - Left - 300/320/350/400/410mm	●	●	○	○	●	●
	WCA848110	Elevating Legrest - Right - 300/320/350/400/410mm	●	●	○	○	●	●
	WCA848120	Elevating Legrest - Left - 450/460/500/510mm	●			○	●	●
	WCA848130	Elevating Legrest - Right - 450/460/500/510mm	●			○	●	●
	WCA848140	Elevating Legrest - Left - 570/610mm	●				●	
	WCA848150	Elevating Legrest - Right - 570/610mm	●				●	
Stump Supports								
16	WCA848220	Stump Support - Left - Silver - 300/320/350/400/450mm	●	●	●	●	●	●
	WCA848230	Stump Support - Right - Silver - 300/320/350/400/450mm	●	●	●	●	●	●
	WCA848240	Stump Support - Left - Silver - 500/550/570/610mm	●			●	●	●
	WCA848250	Stump Support - Right - Silver - 500/550/570/610mm	●			●	●	●
	WCA848260	Stump Support - Extension Bracket - Silver	●	●			●	●
Oxygen Bottle Holders								
17	WCA848290	Oxygen Bottle Holder	●	●			●	●
	WAA695600	Oxygen Bottle Bag			●	●		
Brake Extensions								
18	WCA848310	Brake Extension Lever - Left	●	●			●	●
	WCA848320	Brake Extension Lever - Right	●	●			●	●
Lateral Supports								
19	WCA848430	Lateral Chest Support - Left	●	●				
	WCA848440	Lateral Chest Support - Right	●	●				
	WCA848450	Lateral Chest Support - Left				●		
	WCA848460	Lateral Chest Support - Right				●		

ARTG - 291670 | ARTG - 291393

**KEY**

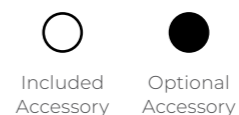

\*Note: Side transfers are not possible when gutter armrests are attached



## Underarm Crutches - Bariatric



- Designed with strength to support the bariatric user
- Steel construction provides durability and support up to 249kg
- Ferrule: 22mm

<b>Code</b>	WAC688200 - Adult/Tall	WAC688300 - Adult/Medium
<b>Height</b>	1750 - 1980mm	1550 - 1750mm
<b>Material</b>	Steel	
<b>Product Weight</b>	4.7 kg	
<b>SWL</b>	249kg	

**SWL 249kg** **1 YEAR WARRANTY**

ARTG - 99895

## Underarm Crutches - Red Dot



- Patented clip - lock adjustable handle and push button foot pieces for fast, precise measuring and fitting
- Lightweight aluminum frame
- High density rubber cushions and hand grips providing long wear and greater comfort
- Ferrule: 22mm

<b>Code</b>	WAC692300 - Child/ Paediatric	WAC692500 - Youth/Small	WAC692200 - Adult/Medium	WAC692400 - Tall/Large
<b>User Height</b>	1220 - 1370mm	1320 - 1570mm	1550 - 1750mm	1780 - 1980mm
<b>Height</b>	787 - 940mm	940 - 1140mm	1120 - 1320mm	1320 - 1520mm
<b>Material</b>	Aluminum			
<b>Product Weight</b>	1.25kg			
<b>SWL</b>	136kg			

**SWL 136kg** **1 YEAR WARRANTY**

ARTG - 99895

## Underarm Crutches - Wing Nut



- Easy to use wing nut height adjustment
- Lightweight aluminium frame
- High density rubber cushions and handgrips providing long wear and greater comfort

<b>Code</b>	WAC692503 - Youth Small	WAC692502 - Adult Medium	WAC692501 - Adult Tall/Large
<b>Height</b>	940 - 1145mm	1120 - 1320mm	1350 - 1520mm
<b>Material</b>	Aluminum		
<b>SWL</b>	136kg		

**SWL 136kg** **1 YEAR WARRANTY**

ARTG - 99895

## Forearm Crutches



- Lightweight and durable forearm crutches to suit a large range of users
- Cuff provides a secure fitting to the forearm
- Adjustable height between cuff and handle and ground
- Ferrule: 22mm

<b>Code</b>	WAC692000 - Youth Small	WAC691400 - Adult Medium	WAC691800 - Adult Tall/Large
<b>User Height</b>	1230 - 1640mm	1480 - 1860mm	1740 - 2040mm
<b>Height</b>	530 - 735mm	635 - 910mm	820 - 1075mm
<b>Material</b>	Aluminum		
<b>Product Weight</b>	1.2kg		
<b>SWL</b>	180kg		

**SWL 180kg** **1 YEAR WARRANTY**

ARTG - 99895

## Forearm Crutches - Ergonomic



- Lightweight and durable forearm crutches to suit a large range of users
- Ergonomic shaped handle distributes the pressure more evenly across the hand
- Cuff provides a secure fitting to the forearm

<b>Code</b>	WAC691500 - Medium	WAC691900 - Large
<b>Height</b>	580 - 835mm	680 - 935mm
<b>Material</b>	Aluminum	
<b>SWL</b>	127kg	

**SWL 127kg** **1 YEAR WARRANTY**

ARTG - 99895

## Forearm Crutches - Kids

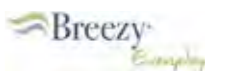

- Just for kids
- These light weight yellow Forearm Crutches are height adjustable
- Ferrule: 18mm

<b>Code</b>	WAC691700 - Child 4 to 7yrs	WAC691600 - Child 6 to 10yrs
<b>Height</b>	406 - 559mm	457 - 656mm
<b>Material</b>	Aluminum	
<b>SWL</b>	100kg	

**SWL 100kg** **1 YEAR WARRANTY**

ARTG - 99895

# Pressure Relief Chairs

---

Patients who spend extended periods of time sitting or lying require specific mobility aids to ensure they remain comfortable and to prevent the development of pressure sores. Uniquely designed to allow immersion and envelopment, pressure relief chairs help to redistribute pressure across the surface of the skin.

Made using specialised fabrics, the Aidacare collection of pressure relief seats and chairs are designed to be comfortable, durable, and easy to clean. Our selection of air comfort chairs also offers users exceptional comfort and relief with the aid of air cushioned seating. Along with our selection of pressure relieving chairs, you will also find a comprehensive range of accessories including leg rests, armrest covers, tray tables, seat covers, seat belts, head cushions, and footplates.

## Mobile Air Chair



Pictured with optional padded footrest

- Promotes skin immersion and envelopment, redistributing skin pressure, reducing the risk of pressure injury
- Lie-flat position converts chair into a bed for prolonged periods of use
- Swing away wings and armrests for improved patient transfer access
- Adjustable foam matrix in backrest
- Gas assisted tilt, recline, and leg raise
- Removable and washable covers for infection control
- Lockable castors with directional control

### OPTIONAL

- Padded Footrest (CHP198860)
- Meal Tray (CHP198861)
- Fold-away Tray Table (CHP198860)



Adjustable Foam Matrix

Code	CHP198850 (Small)	CHP198855 (Large)
Overall Height	1290mm	1290mm
Overall Width	610mm	700mm
Overall Depth	690mm	690mm
Seat Height	650mm	650mm
Seat Width	410mm	500mm
Seat Depth	560mm	560mm
Recline Angle	0° - 90°	0° - 90°
Tilt Angle	0° - 25°	0° - 25°
Leg Raise Angle	0° to 90°	0° - 90°
SWL	180kg	180kg

**3 YEARS WARRANTY Frame**  
**1 YEAR WARRANTY Fabric**

ARTG - 281678

## Shell Chair



- Designed to maximise user access and social interaction in aged care facility or Healthcare environments
- Anterior tilt function for sit to stand transfers reduces manual handling
- Adjustable seat height
- Safety lap belt
- Ergonomic leg rest automatically raises or lowers as the chair is tilted
- Lightweight and manoeuvrable - 12.5" rear wheels with foot brake, 5" front swivel castors

### OPTIONAL

- Footplate (CHP198925)
- Meal Tray (CHP198920)
- Pillow Headrest (CHP198930)

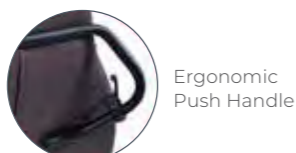

Ergonomic Push Handle

Code	CHP198910 (Medium)	CHP198915 (Large)
Overall Width	700mm	720mm
Overall Depth	890mm	890mm
Seat Height	450 - 530mm	450 - 530mm
Seat Width	450mm	510mm
Seat Depth	440mm	470mm
Forward Tilt Angle	0° - -3°	0° - -3°
Backward Tilt	0° - 27°	0° - 27°
Leg Raise Angle	0° - 90°	0° - 90°
SWL	135kg	135kg

**2 YEARS WARRANTY Frame**  
**1 YEAR WARRANTY Fabric**

ARTG - 277232

## Cove Chair



Available with vinyl outer surface upon request

### OUTCOMES

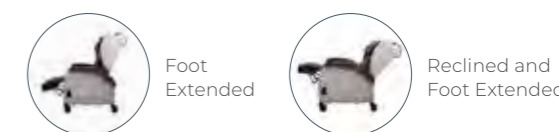

### COLOUR OPTIONS

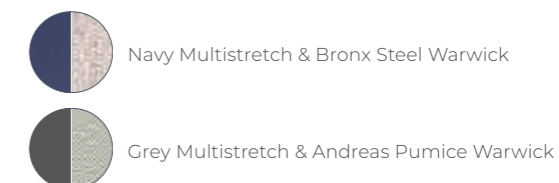

### OPTIONAL ACCESSORIES

- Footrest - CHP198985  
Footrests help enhance patient comfort and reduce discomfort by positioning the legs and feet in a neutral position while seated.
- Tray Table - CHP198980  
Allows for storage of personal items or medical instruments during treatment.
- Advanced Immersion Backrest  
Medium | Grey - CHP198990  
Medium | Navy - CHP198991  
Large | Grey - CHP198992  
Large | Navy - CHP198993

Contouring with an immersive surface for greater lateral support when sitting upright, caters more directly for users with kyphosis.

### Features and Benefits

- For improved postural, pressure care, and comfort for users requiring medium to high level support
- Easily transported to facilitate inclusiveness and social interaction
- Gas assisted leg raise operates independently of tilt to allow infinite positioning combinations and maximise lower leg support
- Anatomical legrest movement, depth adjustable seat, and transitional support armrests
- Adjustable pressure seat cushion - a hybrid air-foam seat cushion with simple reinflation offers convenient pressure adjustment to carers and maintenance staff
- Ergonomic carer push handles
- Complex pressure care compatibility - layered seat structure accommodates after-market pressure care cushions

Code	CHP198965 - Navy / Bronx Steel	CHP198975 - Navy / Bronx Steel
	CHP198960 - Grey / Andreas Pumice	CHP198970 - Grey / Andreas Pumice
Size	Medium	Large
Overall Height	1270mm	1300mm
Overall Width	780mm	830mm
Overall Length	860 - 1640mm	860 - 1690mm
Seat Height	530mm	540mm
Seat Width	550mm	600mm
Seat Range Depth	500 - 580mm	
Seat to Floor Height	540mm	
Seat to Foot Plate	470mm	
Armrest Height	200mm	
Backrest Height	720 - 750mm	
Seat to Top of Back	710mm	770mm
Neutral Backrest Angle	15° (20° including cushion)	
Backrest Tilt Angle Range	20° - 60°	
Neutral Seat Angle	2.5° (5° including cushion)	
Seat Tilt Angle Range	5° - 45°	
Leg Elevation Range	0° - 90°	
Leg Elevation Range w/Tilt	0° - 130°	
SWL	160kg	

ARTG - 373694



## Air Lift Chair



- Adjustable air cell seating redistributes pressure away from bony prominences
- Multistretch pressure reducing backrest offers a breathable and supportive surface for extended sitting and lying
- Firm hand grips improve sit-to-stand efficiency and improve independence
- Removable backrest and seat cushion for easy cleaning and maintenance
- Seat depth is adjustable by 50mm

**SWL 140kg**

**3 YEARS WARRANTY**  
Frame

**1 YEAR WARRANTY**  
Upholstery

Code	CHP198865	CHP198870	CHP198875	CHP198880
Description	Space Saver Petite	Space Saver Large	Dual Action Petite	Dual Action Large
Seat Width	450mm	510mm	450mm	510mm
Seat Depth	460 – 510mm	460 – 510mm	460 – 510mm	460 – 510mm
Backrest Height	610mm	610mm	610mm	610mm
Seat to Floor	480mm	480mm	480mm	480mm
SWL	140kg	140kg	140kg	140kg



## PostureFit Recliner



- A configurable powerlift and recline chair with multiple options for a therapist or carer to ensure the best fit given changing postural and pressure care needs
- Multi stretch pressure reducing patient surface
- Seat width and depth adjustability
- Head tilt and auto extending legrest
- 50mm castors for easy manoeuvrability
- Battery backup
- Provisions to accommodate aftermarket pressure care cushions
- Easily interchangeable backrests options available

**SWL 160kg**

**2 YEARS WARRANTY**

Advanced Immersion      Waterfall style

Code	CHP198250	CHP198260	CHP198290	CHP198295
Description	PostureFit Recliner Medium	PostureFit Recliner Large	Waterfall backrest cushion	Advanced immersion backrest cushion
Seat Width	510 – 560mm	560 – 610mm	-	-
Seat Depth	420 – 480mm	420 – 480mm	-	-
Backrest Angle	95° – 130°	95° – 135°	-	-
Backrest Height	800mm	800mm	-	-
SWL	160kg	160kg	-	-



## Altitude Vertical Lift & Recline Chair



- 4 functions; assisted transfer, recline, vertical lift, and sit-to-stand
- Hand control - large backlit buttons enhance user independence
- Inbuilt battery pack for full chair functionality without powercord
- Transportation handle, multiple grip points
- USB connectivity
- Vertical lift and removable armrests
- Optional wide forearm support
- Tente castors with ultra-low resistance
- Multi-stretch vapour permeable seat and backrest for optimal skin microclimate
- Outer chair surface is upholstered in medical-grade vinyl for infection control

**OPTIONAL**  
Oncology Armrest (CHP227710)  
Armchair Table (CHP227720)  
ROHO Cushion

Code	CHP227700
Overall Height	1200 - 1340mm
Overall Width	710mm
Overall Depth	800mm
Seat Height	560 - 700mm
Seat Width	510mm
Seat Depth	520mm
Seat to Top of Back	710mm
Overall Recline	1780mm
SWL	150kg

**SWL 150kg**

**1 YEAR WARRANTY**



ARTG - 306075

## Altitude Recline Chair



- Pressure reducing mobile electric recliner
- Suitable for multiple environments including aged care, blood/treatment clinics, hospitals or for independent use
- Three-tiered cushion construction provides enhanced patient comfort and immersive qualities
- Inbuilt battery pack for full chair functionality without powercord
- Multi-stretch vapour permeable seat and backrest for optimal skin microclimate
- Outer chair surface is upholstered in medical-grade vinyl for infection control
- 4x 75mm Tente castors for easy relocation

**OPTIONAL**  
Oncology Armrest (CHP227715)  
Armchair Table (CHP227710)  
ROHO Cushion

Code	CHP227705
Overall Height	1200mm
Overall Width	710mm
Overall Depth	800mm
Seat Height	560mm
Seat Width	510mm
Seat Depth	520mm
Seat to Top of Back	710mm
Overall Recline	1780mm
SWL	150kg

**SWL 150kg**

**1 YEAR WARRANTY**



ARTG - 306075

# Milano Manual Chair



**7 YEARS WARRANTY**  
Frame

**1 YEAR WARRANTY**  
Upholstery



This chair gives support, comfort, and pressure management to patients who have low to medium support needs and those who still maintain a degree of mobility. The manual version has gas assisted tilt-in-space, an elevating leg rest, and back angle recline.

### Features and Benefits:

- Tilt, recline, and leg rest controlled by handset
- Tilt in space to allow for re-positioning for pressure care and comfort of the user
- Medium to high pressure management cushion, using memory foam
- Adjustable seat width and depth, and foot plate height
- A light weight frame with directional castors

Code	CHP197995
Overall Height	1400mm
Seat Width	400 - 500mm
Seat Depth	375 - 820mm
Backrest Height	700mm
Seat to Floor	500mm
Unit Weight	52kg
SWL	159kg

ARTG - 246892

# Milano Electric Chair



**7 YEARS WARRANTY**  
Frame

**1 YEAR WARRANTY**  
Upholstery



This chair gives support, comfort, and pressure management to patients who have low to medium support needs and those who still maintain a degree of mobility.

The electric version has a three feature controller handset that includes motorised tilt-in-space, elevating leg rest, and back angle recline. It includes a Linak Lithium Battery Control Box allowing the chair to be used without connection to mains power.

### Features and Benefits:

- Electric tilt, recline, and leg rest controlled by handset
- Tilt in space to allow for re-positioning
- Medium to high pressure management cushion, using memory foam
- Adjustable seat width and depth, and foot plate height
- A light weight frame with directional castors

Code	CHP197997
Overall Height	1130mm
Overall Width	743mm
Overall Depth	1000mm
Seat Height	410mm
Seat Width	600mm
Seat Depth	440mm
Recline Angle	0° - 90°
Leg Raise Angle	0° to 90°
SWL	159kg

ARTG - 246892



## Phoenix Chair



Adjustable Seat Depth

- Effective for seating clients with the following postural conditions: pressure ulcers, reduced upper body tone, kyphosis, scoliosis, muscle contractures, and oedema
- Adjustable head support
- Arm height adjustment
- Backrest recline
- Removable arms
- Elevating legrest
- Manual and powered options

\* Seating Matters Chairs are available in other colour options. Please call 1300 133 120 to discuss your requirements.

<b>Code</b>	Large - Manual (CHP197805) Large - Electric Leg & Tilt (CHP197810) Large - Electric Leg, Recline & Tilt (CHP197815)
<b>Seat Depth</b>	390 - 480mm
<b>Seat Width</b>	400 - 500mm
<b>Total Height</b>	1320mm
<b>Backrest Height</b>	850mm
<b>Seat to Floor</b>	600mm
<b>Unit Weight</b>	67kg
<b>SWL</b>	160kg

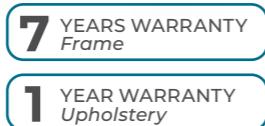

ARTG - 246892

## Phoenix Chair - Paediatric



Unique Adjustable Back and Head Support

- Effective for seating paediatric clients with the following postural conditions: risk of pressure ulcers, reduced upper body control, Kyphosis, Scoliosis, muscle contractures, swelling
- Tilt in space
- Back recline and elevating legrest
- Helps manage pressure
- Forward tilt for stand transfers
- Fully adjustable in under 1 minute, without tools
- Shown with electric adjustment option
- Wide range of accessories available, see end of section for details

\* Seating Matters Chairs are available in other colour options. Please call 1300 133 120 to discuss your requirements.

<b>Code</b>	CHP197800
<b>Seat Depth</b>	290 - 380mm
<b>Seat Width</b>	250 - 400mm
<b>Total Height</b>	1220mm
<b>Backrest Height</b>	680 - 830mm
<b>Seat to Floor</b>	540mm
<b>Unit Weight</b>	57kg
<b>SWL</b>	160kg

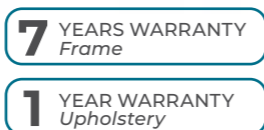

ARTG - 246892

## Sorrento Chair



Bariatric Sorrento Chair

- Effective for seating clients with the following postural conditions: cerebral palsy, spinal cord injury, head injury, stroke, multiple sclerosis, Parkinson's disease, motor neurone disease, dementia, Alzheimer's disease
- Tilt in space
- Adjustable back angle recline
- Seat depth adjustment
- Elevating legrest

<b>Code</b>	CHP197822	CHP197823
<b>Description</b>	Standard	Bariatric
<b>Seat Depth</b>	380 - 480mm	410 - 660mm
<b>Seat Width</b>	350 - 600mm	550 - 850mm
<b>Total Height</b>	1320mm	1320mm
<b>Backrest Height</b>	750mm	750mm
<b>Seat to Floor</b>	600mm	600mm
<b>Unit Weight</b>	62kg	120kg
<b>SWL</b>	160kg	294kg

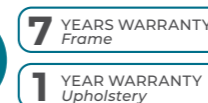

ARTG - 246892

## Atlanta Chair



Integrated Push Handles

- Effective for seating clients with the following postural conditions: Huntington's disease, Alzheimer's, lower limb oedema, cellulitis, advanced dementia, Parkinson's disease, brain injury
- Variable angle leg rest used in combination with the integrated tilt and recline helps to elevate the feet
- Integrated tilt and recline mechanism is fundamental in positioning
- Arm height adjustment
- Sliding footplate
- Removable seat cushion

<b>Code</b>	CHP197820
<b>Seat Depth</b>	480mm
<b>Seat Width</b>	380 - 500mm
<b>Total Height</b>	1135mm
<b>Backrest Height</b>	750mm
<b>Seat to Floor</b>	540mm
<b>Unit Weight</b>	67kg
<b>SWL</b>	160kg



ARTG - 246892

## Monaco Chair



- Effective for seating clients with the following postural conditions: minor stroke reduced, mobility, poor sitting balance, lower limb swelling and oedema, post operative rehab needs, pressure management needs, postural problems
- Ideal for users with reduced mobility or sitting balance
- Unique angle adjustable seat for an optimum and safe sitting position
- Adjustable back angle recline, waterfall back, optional lateral supports, and pressure management materials.
- Variable angle leg rest can be used to elevate the lower limbs and assist in the management of oedema (optional)

<b>Code</b>	CHP197827
<b>Seat Depth</b>	350 - 550mm
<b>Seat Width</b>	380 - 600mm
<b>Total Height</b>	1205mm
<b>Backrest Height</b>	800mm
<b>Seat to Floor</b>	350 - 500mm
<b>Unit Weight</b>	57kg
<b>SWL</b>	160kg



ARTG - 246892



### Aspire Mobile Air Chair Accessories



Footrest



Code	Description
CHP198860	Footrest - Mobile Air Chair

Fold Away Tray Table



Code	Description
CHP198862	Fold-away Tray Table

ARTG - 281678

### Aspire Shell Chair Accessories



Pillow Headrest



Code	Description
CHP198930	Pillow Headrest - Shell Chair

Footplate



Code	Description
CHP198925	Pillow Headrest - Shell Chair

Meal Tray



Code	Description
CHP198920	Tray - Shell Chair

ARTG - 277323

### Seating Matters Accessories



Seat Cushion



Code	Description
CHP197910	350mm - Phoenix Paed Chair
CHP197915	450mm - Phoenix Chair
CHP197920	500mm - Atlanta Chair
CHP197925	Custom - Phoenix, Paed Phoenix & Atlanta Chairs

Head Cushion



Code	Description
CHP197930	Concave - Phoenix, Paed Phoenix & Atlanta Chairs
CHP197935	Horse Shoe - Phoenix, Paed Phoenix & Atlanta Chairs
CHP197940	Standard - Phoenix, Paed Phoenix & Atlanta Chairs

Armrest Cover

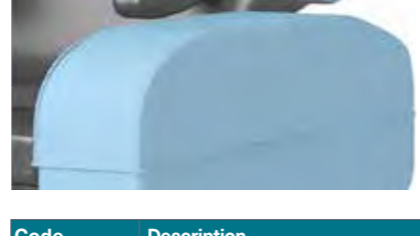

Code	Description
CHP197830	Cover - Phoenix Chair
CHP197835	Cover (1" Padding) - Phoenix Chair
CHP197840	Cover (2" Padding) - Phoenix Chair
CHP197845	Cover (1" Padding) - Phoenix Paed Chair
CHP197850	Cover (2" Padding) - Phoenix Paed Chair
CHP197855	Cover (1" Padding) - Atlanta Chair
CHP197860	Cover (2" Padding) - Atlanta Chair

ARTG - 246892

### Seating Matters Accessories



Twin Castors



Code	Description
CHP197890	Twin Castors - Phoenix, Paed Phoenix & Atlanta Chairs

Variable Leg Rest



Code	Description
CHP197825	Variable Leg Rest - Atlanta Chair

Tray Table



Code	Description
CHP197875	Tray Table - Phoenix, Paed Phoenix & Atlanta Chairs

Removable Seat Cover



Code	Description
CHP197895	Removable Seat Cover - Phoenix, Paed Phoenix & Atlanta Chairs

Padded Footplate



Code	Description
CHP197900	Padded Footplate - Phoenix, Paed Phoenix & Atlanta Chairs

Tilt Angle Display



Code	Description
CHP197905	Tilt Angle Display - Phoenix Chair

Leg Laterals



Code	Description
CHP197864	Leg Laterals - Paediatric Phoenix Chair
CHP197865	Leg Laterals - Phoenix Chair

ARTG - 246892

Lateral Supports



Code	Description
CHP197869	Lateral Supports - aediatric Phoenix Chair
CHP197870	Lateral Supports - Phoenix Chair

Seat Belt

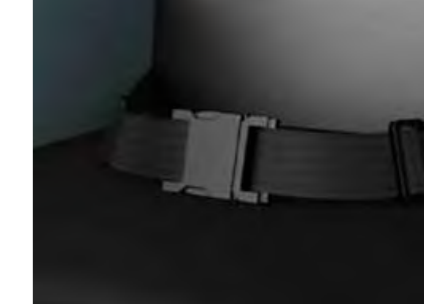

Code	Description
CHP197880	4 Point Seat Belt - Phoenix, Paed Phoenix & Atlanta Chairs
CHP197885	Single Seat Belt - Phoenix, Paed Phoenix & Atlanta Chairs

# Sanitisers and Macerators

---

Central Sterile Services Departments (CSSDs) and pan rooms play vital roles in hospitals and other healthcare facilities. While the pan room accommodates the equipment and utensils required to handle human waste from incapacitated acute care patients, the CSSD manages the cleaning and sterilising of all reusable products and instruments. As such, both are essential elements of hospital hygiene management.

To ensure hospitals are equipped with what they need, Aidacare supplies a range of CSSD and pan room items and equipment. Our selection includes a variety of plasticware and consumables, such as bowls and pans, pulp shapes, detergent, and deodoriser. We also provide high-quality washer sanitisers and macerators, which are ideal for cleaning and steam disinfecting bedpans, urine bottles, slipper pans, bowls, and other utensils.

## Panamatic Optima 3



The Panamatic Optima 3 Washer Sanitiser operates with hot and cold water. The large wash chamber accommodates up to 6 utensils and urine bottles per cycle.

### Features:

- Improved wash performance (Hot and cold water)
- Hands-free open, close and start
- Large capacity chamber
- Easier loading
- + Data logger and dual probes



Greater Versatility



Hands-Free Opening



Easy Loading

<b>Code</b>	UPM100260	<b>Soil Connection</b>	110mm connections supplied
<b>Electrical Supply</b>	Single Phase 230 V, 13 AMP	<b>Operation Cycle Time</b>	Approx 10 mins - 30ml EcoWash
<b>Electrical Output/Input</b>	Motor - 0.75 KW, Heater - 2.5 KW	<b>Steam Disinfection</b>	Exceeds Ao 700, 85°x75 secs
<b>Dimensions (W x D x H)</b>	600 x 600 x 900mm	<b>Typical Capacity</b>	3 bedpans + 3 urine bottles/cycle
<b>Water Supply</b>	15 mm Hot & Cold water 1 - 6 bar	<b>Warranty</b>	1 Year



1 YEAR WARRANTY

ARTG - 203303

## Panamatic Optima 2



The Panamatic Optima 2 Washer Sanitiser operates with cold water version of the Midi. The more compact washer chamber accommodates up to 4 pans and bottles per cycle.

### Features:

- Improved wash performance (hot and cold water)
- Efficient water and power use
- Hands-free open, close and start
- MicrobeSafe antimicrobial lid
- Steam disinfection cycle
- Easier loading
- + Data logger and dual probes



Hands Free Start Cycle



Hands-Free Opening



Easy Loading

<b>Code</b>	UPM100210	<b>Soil Connection</b>	110mm connections supplied
<b>Electrical Supply</b>	Single Phase 230 V, 13 AMP	<b>Operation Cycle Time</b>	Approx 8 mins / 30ml EcoWash
<b>Electrical Output/Input</b>	Motor - 0.75 KW, Heater - 2.5KW	<b>Steam Disinfection</b>	Exceeds Ao 700, 85° x 75 secs
<b>Dimensions (W x D x H)</b>	500 x 600 x 1042mm	<b>Typical Capacity</b>	2 bedpans + 2 urine bottles/cycle
<b>Water Supply</b>	15 mm Hot & Cold 1 - 6 bar	<b>Warranty</b>	1 Year



1 YEAR WARRANTY

ARTG - 203303

## Panamatic Midi



The Panamatic Midi Washer Sanitiser operates with cold water and is designed for low-medium workload situations.

### Features:

- Cold water wash
- Efficient water and power use
- Hands-free open, close, and start
- MicrobeSafe antimicrobial lid
- Large chamber capacity
- Easier loading
- + Data logger and dual probes



Hands Free Start Cycle



Hands-Free Opening



Easy Loading

<b>Code</b>	UPM100310	<b>Soil Connection</b>	110mm connections supplied
<b>Electrical Supply</b>	Single Phase 230 V, 13 AMP	<b>Operation Cycle Time</b>	Approx 7 mins / 30ml EcoWash
<b>Electrical Output/Input</b>	Motor - 0.425KW, Heater - 2.5KW	<b>Steam Disinfection</b>	Exceeds Ao 700, 85° x 75 secs
<b>Dimensions (W x D x H)</b>	500 x 600 x 1042mm	<b>Typical Capacity</b>	2 bedpans + 2 urine bottles/cycle
<b>Water Supply</b>	15 mm cold water 0.5 - 10 bar	<b>Warranty</b>	1 Year



1 YEAR WARRANTY

ARTG - 203303

## Pulpmatic Eco + Macerator



The Pulpmatic Eco+ Medical Pulp Macerator features cross-infection control combined with improved environmental performance and ease of use.

### Features:

- Blockage free processing
- Hands-free open, close and start
- Large chamber capacity, reduced water consumption
- Automatic sanitation cycle
- Includes programmable audio messaging
- Water Supply: 15mm cold water 0.5 - 10 bar
- Soil Connection: 50mm P Trap to 110mm waste
- Operation cycle time: from 85 seconds / 8ml EcoCleanse
- Typical Capacity: 3 large or 6 small pulp products



Hands Free Start Cycle



Hands-Free Opening



Greater Versatility

<b>Code</b>	UPM100130	<b>Soil Connection</b>	50mm P Trap to 110mm waste
<b>Electrical Supply</b>	Single Phase 230 V, 15 AMP	<b>Operation Cycle Time</b>	From 85 seconds / 8ml EcoCleanse
<b>Electrical Output/Input</b>	0.75kW, Noise: 59.5 dba	<b>Steam Disinfection</b>	3 large or 6 small pulp products
<b>Dimensions (W x D x H)</b>	500 x 600 x 1042mm	<b>Typical Capacity</b>	1 Year
<b>Water Supply</b>	15mm cold water 0.5 - 10 bar	<b>Warranty</b>	1 Year



1 YEAR WARRANTY

ARTG - 203303



## Detergent and Deodoriser



Macerator Deodoriser 5L



Sanitiser Detergent 5L



Macerator Deodoriser Concentrate - 1L

- Kills 99% of bacteria and viruses
- Maximum sanitisation and germ kill. Not classified as hazardous
- For use in DDC Pulpmatic Macerators and Washer Sanitisers

### OPTIONAL



Wall cabinet with combination lock (UPA200100)



Detergent Basket Lockable (UPA300300)



Wall cabinet with combination lock  
Fits 2x 5L Units  
Fits 12x 1L Units

Code	Description
UPD300110	Sanitiser Detergent - Carton of 2 - 5L
UPD300120	Macerator Deodoriser - Carton of 2 - 5L
UPD300125	Macerator Deodoriser - Carton of 12 - 1L
UPW300220	Fluid Absorption Paper Sachets - Box of 100
UPA300300	Detergent Basket - Lockable
UPA200100	Wall cabinet with combination lock

ARTG - 203303

## Drying Racks



Stainless Steel 4 Bedpan 4 Urine Bottle Drying Rack

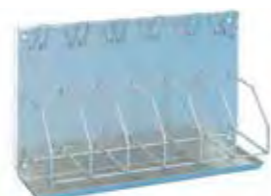

Stainless Steel 6 Bedpan 6 Urine Bottle Drying Rack

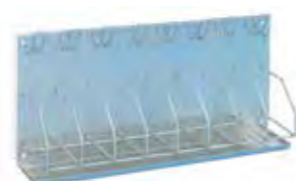

Stainless Steel 8 Bedpan 8 Urine Bottle Drying Rack



Stainless Steel Wall Mounted Basin Rack



Stainless Steel Wall Mounted Shelf (Drip Tray Only)

Code	Description
UPA200276	Stainless Steel 4 Bedpan 4 Urine Bottle Drying Rack
UPA200277	Stainless Steel 6 Bedpan 6 Urine Bottle Drying Rack
UPA200278	Stainless Steel 8 Bedpan 8 Urine Bottle Drying Rack
UPA200280	Stainless Steel Wall Mounted Basin Rack
UPA200285	Stainless Steel Wall Mounted Shelf (Drip Tray Only)

ARTG - 203303



## Meiko Sanitisers

Meiko is a recognised global leader in cleaning and disinfection solutions. Meiko combines German engineering and design to deliver a compact, flexible, and highly-functional range of front-loading sanitiser solutions. In addition to equipment supply, Meiko offer full sluice / clean-room design options and a large range of complimentary accessories. Meiko equipment is water and energy efficient and is cost-effective to maintain with only a single annual service recommended.

### Topic Range

The TOPIC range of sanitisers from MEIKO are available in a wall-mounted (Topic 10); floor mounted (Topic 20); under-bench (Topic 30); and cabinet (Topic 40) versions. The TOPIC range is offered as a more economical choice with fewer features than the premium TOPLINE range. The TOPIC range offers full standards-compliant disinfection and great features (such as hands-free open/close in the AT model) to reduce cross-contamination.



### Topic 10 & Topic 20



Topic 10 Wall Mounted

Topic 20 Floor Mounted

- Simple and logical electronic interface with clear detergent and temperature indicators help reduce wash errors
- Temperature data logging, hands-free open/close (with AT model), warm and cold water supply
- Total system disinfection after each completed wash cycle
- Capacity: 2 bed pans and 2 urine bottles or 3 urine bottles
- 3 Program options (short / normal / intensive), variable cycle times
  - Short: 24 bed pans and 24 urine bottles or 36 urine bottles per hour
  - Normal: 11 bed pans and 11 urine bottles per hour
  - Intensive: 9 bed pans and 9 urine bottles per hour
- Efficient water use: short (23L); normal (31L); intensive (39L)
- Energy efficient at 235 watts: 240V, 50Hz, 16A, 3kw. 3-phase connection
- Complies with AS4187:2014 > ISO 15883, 1 and 3.
- Low maintenance cost- serviced once in a year or every 5000 cycles

Code	UPM200500	UPM200510	UPM200520	UPM200530
Description	Sanitiser - Meiko - Topic 10	Sanitiser - Meiko - Topic 10 AT with Auto Door	Sanitiser - Meiko - Topic 20	Sanitiser - Meiko - Topic 20 AT with Auto Door & Foot
Width	500mm	500mm	500mm	500mm
Depth	450 - 600mm	450 - 600mm	450 - 600mm	450 - 600mm
Height	1630mm	1630mm	1730mm	1730mm



ARTG - 164116

### Topic 20 XL



Floor Mounted

For high-volume workflow solutions, MEIKO offer the TOPIC 20 in a side-by-side configuration called the 'XL'. The benefits of this solution include:

- Dual usage provides high-flow during peak-use periods. Single usage during quieter periods increases efficiency by decreasing water and electricity use and cycle times
- System redundancy in the event of an outage helps ensure operational continuity
- Utilises existing water and electrical connections to ensure installation cost-effectiveness

Code	UPM200540	UPM200550
Description	Sanitiser - Meiko - Topic 20 XL (side-by-side)	Sanitiser - Meiko - Topic 20 XL AT (side-by-side) with Auto Door & Foot
Width	1000mm	1000mm
Depth	450 - 600mm	450 - 600mm
Height	1730mm	1730mm



ARTG - 164116

## Topline Range



The TOPLINE range of sanitisers from MEIKO are available in Wall Mounted (Topline 10) or Floor Mounted (Topline 20) ; Under-bench (Topline 30); and Cabinet (Topline 40) versions. The TOPLINE range is offered as a premium choice with additional features to the economical TOPIC range. The TOPLINE range offers, as standard, telescoping spray-nozzles which penetrate up-into bed-pans and ensure that active cleaning occurs inside the pan and under edges. The TOPLINE range offers, as standard, a drying and cooling cycle thus eliminating steam emissions and negating the need for drip trays thus saving space in the utility room.

### General Features

- Telescoping Rotary Jet to ensure the inside of bed pans is cleaned
- Cooling and drying cycle on completion ensures devices are dry when removed, thus reducing the need for drip-trays and drying racks

## Topline 10 & Topline 20



Topline 10  
Wall Mounted

Topline 20  
Floor Mounted

- Simple and logical electronic interface for staff with clear program selection and alert indicators
- Hands-free open/close (with AT model)
- Warm and cold water supply
- Total system disinfection- disinfects all water channels after each completed wash cycle to avoid the risk of recontamination.
- 3 Program options (short / normal / intensive) for disinfection from A060 (Short) to A03000 (Intensive) - for higher disinfection value
- Variable cycle times depending on program option: short (5min); normal (5.5min); intensive (6min)
- Capacity: 2 bed pans and 2 urine bottles or 3 urine bottles
  - Short program: 24 bed pans and 24 urine bottles or 36 urine bottles per hour
  - Normal program: 11 bed pans and 11 urine bottles per hour
  - Intensive program: 9 bed pans and 9 urine bottles per hour
- Efficient water use depending on program option: short (23 L); Normal (31 L); Intensive (39 L)
- Energy efficient at 235 watts: 240V, 50Hz, 16A, 3kw. 3-phase connection
- Complies with AS4187:2014 > ISO 15883, 1 and 3
- Low maintenance cost- serviced once in a year or every 5000 cycles

Code	UPM200100	UPM200110	UPM200120	UPM200130
Description	Sanitiser - Meiko - Topline 10	Sanitiser - Meiko - Topline 10 AT with Auto Door	Sanitiser - Meiko - Topline 20	Sanitiser - Meiko - Topline 20 AT with Auto Door & Foot
Width	500mm	500mm	500mm	500mm
Depth	450 or 588mm	450 or 588mm	450 - 588mm	450 - 588mm
Height	1630mm	1630mm	1730mm	1730mm

**1** YEAR WARRANTY

ARTG - 164116

## Meiko Accessories and Others



1. Basket Insert With Hinged Lid



ARTG - 164116

2. Basket With Hinged Lid



ARTG - 164116

3. Bottle Rack 8 Urine Bottles



ARTG - 164116

4. Bottle Rack 11 Urine Bottles



ARTG - 164116

5. Pan & Bottle Rack 9 Pan & 9 Bottle

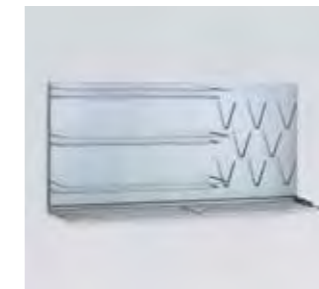

ARTG - 164116

6. Pan & Bottle Rack 6 Pan & 6 Bottle



ARTG - 164116

7. Pan Rack 12 Pans



ARTG - 164116

8. Pan Rack 3 Pans



ARTG - 164116

9. Pan Rack 6 Pans



ARTG - 164116

10. Pan Rack 9 Pans



ARTG - 164116

11. Pan Rack (Not Mounted) - 4 Pan



ARTG - 164116

12. Pan Rack (Not Mounted) - 8 Pan



ARTG - 164116



## Meiko Accessories and Others



13. SUH 1 Internal rack



ARTG - 164116

14. SUH 2 Quick-change rack



ARTG - 164116

15. Quick Change Rack with Bag Empty



ARTG - 164116

16. Bag Emptying Rack (internal)



ARTG - 164116

17. Drip tray



ARTG - 164116

18. Detergent



ARTG - 213257

19. Rinse Aid



ARTG - 213256

	Code	Description	Width	Depth	Height
1	UPA400100	Basket insert with hinged lid - Meiko	-	-	-
2	UPA400110	Basket with hinged lid for small items - Meiko	-	-	-
3	UPA400200	Bottle Rack - Meiko TU50 - 8 Urine Bottles (drip tray sep)	500mm	350mm	650mm
4	UPA400210	Bottle Rack - Meiko TU70 - 11 Urine Bottles (drip tray sep)	700mm	350mm	650mm
5	UPA400250	Pan & Bottle Rack - Meiko TUS 140 - 9 Pan & 9 Bottle (drip tray sep)	1400mm	350mm	650mm
6	UPA400260	Pan & Bottle Rack - Meiko TUS 50 - 6 Pan & 6 Bottle (drip tray sep)	500mm	350mm	650mm
7	UPA400300	Pan Rack - Meiko TS100 - 12 Pans (drip tray sep)	1000mm	350mm	650mm
8	UPA400310	Pan Rack - Meiko TS50 - 3 Pans (drip tray sep)	500mm	350mm	650mm
9	UPA400320	Pan Rack - Meiko TS70 - 6 Pans (drip tray sep)	700mm	350mm	650mm
10	UPA400330	Pan Rack - Meiko TS90 - 9 Pans (drip tray sep)	900mm	350mm	650mm
11	UPA400340	Pan Rack (Not Mounted) - Meiko - For vertical storage of bedpans - 4 Pan	-	-	-
12	UPA400350	Pan Rack (Not Mounted) - Meiko - For vertical storage of bedpans - 8 Pan	-	-	-
13	UPA400400	Rack (Internal) - Meiko - SUH 1 Internal rack (Non-standard in Aust)	-	-	-
14	UPA400410	Rack (Internal) - Meiko - SUH 2 Quick-change rack (Standard in Aust)	-	-	-
15	UPA400420	Rack (Internal) - Meiko - TopCut B - Quick Change Rack with Bag Empty	-	-	-
16	UPA400430	Rack (Internal) - Meiko - TopCut H - Bag Emptying Rack (internal)	-	-	-
17	UPA400500	Drip tray (For all wall-mounted racks) - Meiko - Stainless Steel (order with rack)	-	-	-
18	UPD400100	Detergent - Meiko - Doyen R100 (5 ltr x 2 containers)	-	-	-
19	UPD400110	Rinse Aid - Meiko - Doyen SK 22 (5 ltr x 2 containers)	-	-	-

## Pans and Bowls



1. Bed Pan Slipper



ARTG - 203303

2. Bed Pan



ARTG - 203303

3. Wash Bowls



4. Kidney Dishes



5. Urine Bottle - Female



ARTG - 203303

6. Urine Bottles - Male



ARTG - 203303

7. Bowl with Handle & Lid



ARTG - 203303

8. Bed Pan Liner Support



ARTG - 203303

9. Slipper Pan Liner Support



ARTG - 203303

	Description	Code
1	Bed Pan Slipper - Small	BTT148000
	Bed Pan Slipper - Large	BTT161500
2	Bed Pan	BTT151800
3	Wash Bowl - 600ml	WAT769800
	Wash Bowl - 1500ml	WAT770000
	Wash Bowl - 3500ml	WAT761200
4	Kidney Dish - 800ml	WAT770700
	Kidney Dish - 700ml - clear	WAT770400
	Kidney Dish - 600ml	WAT770600
5	Urine Bottle - Female	BTT148700
	Urine Bottle - Male - green	BTT145700
6	Urine Bottle - Male - clear	BTT160900
7	Bowl with Handle & Lid	BTC081610
8	Bed Pan Liner Support	UPP100110
9	Slipper Pan Liner Support - Midi	UPP100115
	Slipper Pan Liner Support - Maxi	UPP100120

## Pulp Trays

1. Pulp - Slipper Pan - Midi



2. Pulp - Slipper Pan - Maxi



3. Pulp - Bed pan



4. Pulp - Kidney Dish



5. Pulp - Male Urine Bottle



6. Pulp - GP Bowl - 1000ml



7. Pulp - GP Bowl - 3000ml



8. Pulp - Commode Bowl



ARTG - 203303

	Description	Code
1	Pulp Slipper Pan -Midi - 1300ml	UPP100215
2	Pulp Slipper Pan-Maxi - 2000ml	UPP100220
3	Pulp Bedpan - 2000ml	UPP100210
4	Pulp Kidney Dish - 700ml	UPP100230

	Description	Code
5	Pulp Male Urine Bottle - 900ml - Square	UPP100245
	Pulp Male Urine Bottle - 875ml - Bulbous	UPP100250
6	Pulp GP Bowl - 1000ml	UPP100235
7	Pulp GP Bowl - 3000ml	UPP100240
8	Pulp Commode Bowl - 1700ml	UPP100225



# Maternity

---

Aidacare offers specialised equipment to cater to the needs of many different hospital wards and departments, including maternity wards. Our selection of products for maternity wards includes delivery and maternity beds, baby cots, and support person chairs. All items included in our range are designed and manufactured for superior safety, comfort, durability, hygiene, and function. Our delivery beds are robust and sturdy while our cots offer the comfort and safety required for the care of newborn babies.

The Aidacare maternity range features products from a curated selection of reputable brands and labels. These brands are highly trusted and known within the industry for providing exceptional hospital equipment.

## Smile Paediatric Ward Bed



- Three function electrically adjustable paediatric bed designed with growing people in mind
- Colourful side rails and decals to meet interior design themes and add to a more cheerful patient environment
- Capacity to lengthen at the press of a button to transition from child to young adult size proportions
- Durable blow molded side rails with gas spring dampeners for smooth operation
- Onboard battery provides ward mobility and emergency backup
- Integrated control panel in foot end section for carer and parent access

Code	PED490100
Overall Length	1830 - 2180mm
Overall Width	890mm
Overall Height	550 - 950mm
Patient Surface Length	1580 - 1980mm
Patient Surface Width	890mm
Backrest Angle	0° - 70°
Knee Bend Angle	0° - 36°
Trendelenburg	-15° - 15°
Castor Size	150mm
SWL	150kg

### OPTIONAL

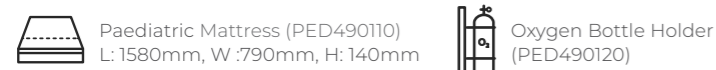

**SWL 150kg** **INFECTION CONTROL** **BIOCOTE**  
Antibacterial frame coating for improved infection control

**2 YEARS WARRANTY**

ARTG - 294877

## Matris Rooming-In Crib



- Transparent side panels allow full visibility
- Ventilation sections in either end to promote flow of clean air to the baby
- Drop down side sections allow reinforced padded side sections to lay across the gap between crib and bed. This creates a:
  - More natural and intimate maternal bonding experience
  - Safe lateral transfer of the baby
- Automatically locking 125mm castors ensure stability and safety with active handle compression required for brake release
- Integrated Trendelenburg tilt function to assist with clinical requirements such as relieving reflux
- Gas assisted height adjustment for ergonomically sound manual handling for mother and baby

Code	PED490200
Overall Length	890mm
Overall Width	520mm
Overall Height	490 - 710mm
Patient Surface Length	660mm
Patient Surface Width	340mm
Trendelenburg	-6° - 12°
Castor Size	125mm

### OPTIONAL

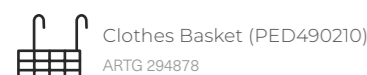

**INFECTION CONTROL** **BIOCOTE**  
Antibacterial frame coating for improved infection control

**2 YEARS WARRANTY**

ARTG - 294878

## Baby Bassinet



- Transparent and durable ABS bassinet provides cradled comfort for newborns
- Heavy-duty stainless-steel frame and wipe clean surfaces
- Seamless foam mattress with multi-stretch medical grade Carrflex fabric and an in-built mesh extrusion for optimal breathability
- Hospital-grade castors: 100mm locking castors
- Bassinet elevation to reduce the effects of reflux
- Ward label for asset identification
- 2x polypropylene utility tubs for accessible storage

Code	PED490240
Overall Length	795mm
Overall Width	450mm
Overall Height (Inc. Bassinet)	1050mm
Bassinet Length	710mm
Bassinet Width	360mm
Product Weight	20kg
SWL	30kg

**3 YEARS WARRANTY**  
Frame

**1 YEAR WARRANTY**  
Bassinet/Tubs



ARTG - 303540

## Paediatric Cot



- Paediatric Cot features a stainless steel and epoxy coated frame
- 4x locking castors
- Mechanisms to operate drop sides located outside of the cot at mattress base for added safety
- Hand operated Trendelenburg 12° above horizontal
- Meets AS 2130

### OPTIONAL



Code	WAT830550
Overall Length	1430mm
Overall Width	875mm
Overall Height	1560mm
SWL	40kg



## Sleeper Chair



- Converts from a chair to a comfortable sleeping surface
- Durable seat construction preserves shape and comfort in a high use environment
- Single hand activation to convert from chair to sleep surface
- Recessed locking castors offer easy positioning and accessibility
- Completely flat sleep surface to maximise rest and relaxation
- Contemporary design compliments a range of care environments

### COLOUR OPTIONS



Completely flat sleep surface to maximise rest and relaxation



Code	CHP198810 - Beige
Code	CHP198816 - Navy
Overall Height	780mm
Overall Width	760mm
Overall Depth	960mm
Seat Height	370mm
Seat Width	600mm
Seat Depth	580mm
Backrest Height	410mm
SWL	150kg

# Patient Handling: Mobile

---

Patient handling is a necessary part of any hospital environment, but it can also be strenuous and potentially dangerous for both patient and nurses or carers.

The right equipment can make moving and transferring hospital patients simpler and safer. At Aidacare, we provide a variety of patient handling equipment that can eliminate or reduce the need for manually lifting and moving patients. Our products can suit a range of needs, providing support and assistance when needed.

The Aidacare range of patient handling equipment includes patient lifters and slings, ceiling hoists, movers, slide sheets, and evacuation sheets. We also offer an assortment of items that are ideal for bariatric patients. All items in our range are expertly manufactured for safe and easy use.



## Golvo 9000 Patient Lifter



- Vertical lifting motion with flexible lift strap is ideal for horizontal lifting, ambulation, and lifting from the floor
- Parallel base-width adjustment contributes to easier lifting of patients to/from chairs, beds, and the floor
- Armrests help to support patients during ambulation and make it easier for caregivers to manoeuvre the lift
- User display highlights device usage, including lift count, service required indicator, and overloads
- Optional quick-release hook system means caregivers can easily and rapidly change a sling bar or install a scale
- Ergonomic hand control for lift operation displays both battery usage and overload indicators

\* An extensive assortment of accessories is available including slings, slingbars and scales

**SWL 200kg**

**10 YEARS WARRANTY**  
Frame

**2 YEARS WARRANTY**  
Electrical Parts

ARTG - 367375



### OPTIONAL

- Quick Release Hook
- Range of Slings

<b>Code</b>	LSS393100
<b>Overall Height</b>	2090mm
<b>Overall Length</b>	1185mm
<b>Overall Width</b>	735 - 1020mm
<b>Lifting Height</b>	571 - 1816mm
<b>Material</b>	Aluminium
<b>Leg Function</b>	Electric
<b>SWL</b>	200kg

## Golvo 9000 LowBase Patient Lifter



- Allows for even greater clearance under low beds or stretchers versus the standard model
- Armrests help to support patients during ambulation, as well as making it easier for caregivers to manoeuvre the lift
- Vertical lifting motion with flexible lift strap is ideal for horizontal lifting, ambulation and lifting from the floor
- Parallel base-width adjustment contributes to easier lifting of patients or residents to/from chairs, beds and the floor as well as making it easier for caregivers to manoeuvre the lift
- User display highlights device usage, including lift count, service required indicator, and overloads
- Ergonomic hand control for lift operation displays both battery usage and overload indicators

\*An extensive assortment of accessories is available including slings, slingbars and scales

**SWL 200kg**

**10 YEARS WARRANTY**  
Frame

**2 YEARS WARRANTY**  
Electrical Parts

ARTG - 367375



### OPTIONAL

- Quick Release Hook
- Range of Slings

<b>Code</b>	LSS393105
<b>Overall Height</b>	2090mm
<b>Overall Length</b>	1185mm
<b>Overall Width</b>	745 - 1028mm
<b>Lifting Height</b>	571 - 1816mm
<b>Material</b>	Aluminium
<b>Leg Function</b>	Electric
<b>SWL</b>	200kg

## Viking M Patient Lifter



**SWL 205kg**

**10 YEARS WARRANTY**  
Frame

**2 YEARS WARRANTY**  
Electrical Parts

ARTG - 367374

- Ideal for lifting in small spaces
- Control box shows number of lift cycles, battery, lift overload, and service indicator
- Optional armrests help support patients during ambulation and make it easier for caregivers to manoeuvre the lift
- Three variable height settings
- Intuitive and ergonomically-designed hand control has indicators for low battery level and when exceeding the Safe Working Load
- An extensive assortment of accessories is available including slings, slingbars, and scales



### OPTIONAL

- Universal Slingbar
- Range of Slings

<b>Code</b>	LSS393190
<b>Overall Height</b>	1340-2020mm
<b>Overall Length</b>	1230mm
<b>Overall Width</b>	690 - 1110mm
<b>Lifting Height</b>	420 - 1790mm
<b>Material</b>	Aluminium
<b>Leg Function</b>	Electric
<b>SWL</b>	205kg

## Viking L Patient Lifter



**SWL 250kg**

**10 YEARS WARRANTY**  
Frame

**2 YEARS WARRANTY**  
Electrical Parts

ARTG - 367374

- An everyday flexible lifting solution
- Control box displays number of lift cycles, battery level, lift overload, and service indicator
- Optional armrests help support patients during ambulation as well as making it easier for caregivers to manoeuvre the lift
- Intuitive and ergonomically-designed hand control has indicators for low battery level and when exceeding the Safe Working Load
- An extensive assortment of accessories is available including slings, slingbars and scales



### OPTIONAL

- Universal Slingbar
- Range of Slings

<b>Code</b>	LSS393180
<b>Overall Height</b>	2030mm
<b>Overall Length</b>	1360mm
<b>Overall Width</b>	695 - 1070mm
<b>Lifting Height</b>	460 - 1790mm
<b>Material</b>	Aluminium
<b>Leg Function</b>	Electric
<b>SWL</b>	250kg

## Viking XL Patient Lifter



**SWL 300kg**

**10 YEARS WARRANTY**  
Frame

**2 YEARS WARRANTY**  
Electrical Parts

**BARIATRIC**

ARTG - 367374

- Ideal for bariatric lifts and transfers
- Control box displays number of lift cycles, battery level, lift overload and service indicator
- Optional quick-release hook system so caregivers can easily and rapidly change a slingbar or install a scale
- Optional armrests help support patients during ambulation as well as making it easier for caregivers to manoeuvre the lift
- Intuitive and ergonomically-designed hand control has indicators for low battery level and when exceeding the Safe Working Load



### OPTIONAL

- Universal TwinBar 670 Slingbar
- Range of Slings

<b>Code</b>	LSS393170
<b>Overall Height</b>	2110mm
<b>Overall Length</b>	1420mm
<b>Overall Width</b>	815 - 1130mm
<b>Lifting Height</b>	540 - 1910mm
<b>Material</b>	Aluminium
<b>Leg Function</b>	Electric
<b>SWL</b>	300kg

## Sabina II EE Standing Lifter



- Easily changeable sling bars - narrow sling bar (350 SlingBar) for Liko SupportVest or Liko SafetyVest, the wider comfort slingbar for ComfortVest™
- Conventional patient lifting to a limited extent, lifting in the sitting position
- Powerful lifting motor for smooth raising and lowering of patients
- Base-width adjustment for flexibility of use, enhancing patient mobility
- Adjustable height settings to accommodate patient sizes

### OPTIONAL



Code	LSS393250
Overall Height	900 - 1000mm
Overall Length	1060mm
Overall Width	695 - 1115mm
Lifting Height	1050 - 1725mm
Material	Steel
Leg Function	Electric
SWL	200kg

\*Sling Bar Sold Separately

**10 YEARS WARRANTY**  
Frame

**2 YEARS WARRANTY**  
Electrical Parts

SWL 200kg

ARTG - 365574

## Original Highback Sling with Head Support Mod.200/210



- Offers a reclined seating position for patients with poor head and trunk stability
- Separated leg supports ensure that the patient does not sit on the sling after use
- Easily adaptable to the patient with comfortable full body support
- Can be used for floor transfers

### MATERIALS

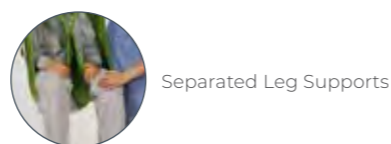

Size	XS	SML	MED	LRG	XL
Code (Polyester)	LSS394610	LSS394620	LSS394630	LSS394640	LSS394650
Code (Net Polyester Mesh)	LSS394660	LSS394670	LSS394680	LSS394690	LSS394700
SWL	200kg	200kg	200kg	200kg	300kg

SWL 200kg

SWL 300kg

**1 YEAR WARRANTY**

ARTG - 362803

## Soft Original Highback Sling with Head Support Mod.26



- Soft pliable plate for support when lifting from the recumbent position
- Reclined seating position for patients with poor head and trunk stability
- Separated leg supports ensure patient does not sit on the sling after use
- Easily adaptable to the patient with comfortable full body support
- Can be used for floor transfers
- Reinforced leg and back supports

### MATERIALS

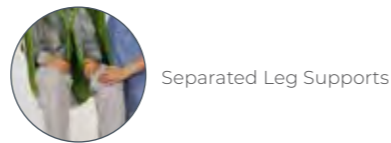

Size	MED	LRG	XL	XXL
Code (Net Polyester Mesh)	LSS394570	LSS394580	LSS394590	LSS394600
Code (Polyester)	LSS394560 (Slim)			
SWL	200kg	200kg	500kg	500kg

SWL 200kg

SWL 500kg

**1 YEAR WARRANTY**

ARTG - 362803

## ComfortSling Plus High with Head Support Mod.350



- Adapts to the body's contours without the need for individual adjustment
- Allows the patient to remain in the sling after application and transfer
- Enhanced width increases patient comfort
- Sling provides comfortable sitting posture with good back support

### MATERIALS



SWL 200kg

SWL 300kg

**1 YEAR WARRANTY**

ARTG - 364530

Size	MED	LRG	XL
Code (Net Polyester Mesh)	LSS394710	LSS394720	LSS394730
SWL	200kg	200kg	300kg

## SilhouetteSling with Head Support Mod.22



- Pliable sling that adapts to the body and requires minimal wheelchair space
- Recommended for lifting to sitting to/from close-fitting wheelchairs
- Provides a slightly reclined sitting posture suitable for patients with poor trunk stability
- Suitable to be used during bathing

### MATERIALS

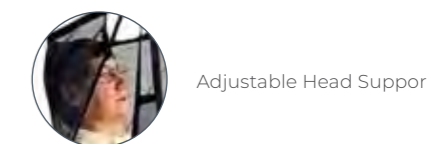

SWL 200kg

**1 YEAR WARRANTY**

ARTG - 364531

Size	XS	SML	MED	LRG
Code (Mesh)	LSS394450	LSS394460	LSS394470	LSS394440
SWL	200kg	200kg	200kg	200kg

## HygieneSling With Belt Mod.41



- Easy to apply sling that enables quick, smooth, and secure transfers
- Equipped with a large opening that facilitates dressing and undressing
- Works well with patients regardless of what clothing they are wearing
- Recommended for lifting to sitting to/from close-fitting wheelchairs
- Suitable to be used during bathing
- Reinforced leg support

### MATERIALS



SWL 200kg

SWL 300kg

**1 YEAR WARRANTY**

ARTG - 364529

Size	SML	MED	LRG	XL
Code (Polyester)	LSS394480	LSS394490	LSS394500	LSS394510
SWL	200kg	200kg	200kg	300kg



### Amputee Highback Sling with Head Support Mod.75



- Designed for safe and secure lifting of patients with single and double leg amputations or contractures
- Can also be used for non-amputee patients who are slender and require a smaller sling
- Offers a sitting posture that is slightly reclined with leg supports applied parallel to each under both thighs
- Adjustable head support
- Reinforced leg support

#### MATERIALS

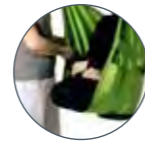
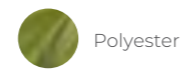

Supports patient with leg amputations



1 YEAR WARRANTY

Size	SML	MED	LRG	XL
Code (Polyester)	LSS394520	LSS394530	LSS394540	LSS394550
SWL	200kg	200kg	200kg	300kg

ARTG - 362814

### UltraSling Bariatric Sling Mod.06



- Designed for safe and comfortable lifting of bariatric patients
- Supports the entire back up to the shoulders
- Leg supports are installed individually on the sling bar, which gives the stomach space and the legs optimal support

#### MATERIALS

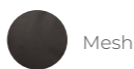
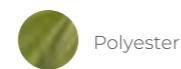

Leg Support



1 YEAR WARRANTY

Size	REGULAR
Code (Polyester)	LSS394410
Code (Mesh)	LSS394430
SWL	500kg

ARTG - 365573

### Solo Highback Disposable Sling with Head Support Mod.25



- Designed for single patient use
- Can be used in most lifting situations
- Designed to adapt to the patient without any individual adjustments
- Strong non-woven polypropylene fabric that is non-washable and engineered to be disposed of when it has become soiled or when the patient no longer requires it
- Adaptable design
- Boxes of 20 (M-LG) & 8 (XL)

#### MATERIALS

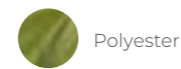

1 YEAR WARRANTY

Size	MED	LRG	XL
Code (Polyester)	LSS394750	LSS394760	LSS394770
	LSS394740 (Slim)		
SWL	200kg	200kg	500kg

ARTG - 362804

### SupportVest Standing Sling Mod.91



- Comfortable sling which lifts behind the back and under the arms
- Easy to use and requires only minimal individual adjustment so suit any patient
- Soft padding redistributes pressure evenly
- Supportive belt holds the vest in place at all times

#### MATERIALS



Size	SML	MED	LRG	XL
Code (Polyester)	LSS394120	LSS394130	LSS394140	LSS394150
SWL	200kg	200kg	200kg	200kg

ARTG - 365575

### ComfortVest Standing Sling Mod.95



- Sit-to-stand sling designed especially for patients who must avoid underarm pressure
- Outer vest supports the patient behind the back and outside the arms, while the inner waist belt prevents gliding and keeps the patient from sliding out of the vest
- Self-regulating tensioning function
- Ideal for patients who are paralysed on one side or have other conditions that inhibit underarm pressure

#### MATERIALS

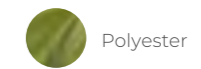

Outer Vest Supports



Size	SML	MED	LRG	XL
Code (Polyester)	LSS394180	LSS394190	LSS394200	LSS394210
SWL	200kg	200kg	200kg	200kg

ARTG - 364530

### SafetyVest Standing Sling Mod.93



- Sit-to-stand sling to assist patients with poor stability
- Self-regulating tensioning function ensures both caregiver and patient feel secure
- Padded fabric provides high degree of friction and prevents gliding
- Sheepskin padding is available for even more comfort (optional)

#### MATERIALS



#### OPTIONAL



Sit-to-Stand Sling

\*Sabina seat strap not included



Size	MED	LRG
Code (Polyester)	LSS394160	LSS394170
SWL	200kg	200kg

ARTG - 365575



## HygieneVest Toileting Sling Mod.55



- Designed for safe and comfortable transfers to and from the toilet
- Works well in complicated situations, such as when lifting amputees or patients with poor muscle tone
- Vest section firmly supports the upper body during transfer, while a generous opening leaves the lower body free for dressing and undressing

### MATERIALS

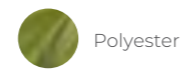

Polyester

Size	SML	MED	LRG	XL
Code (Polyester)	LSS394220	LSS394230	LSS394240	LSS394250
SWL	200kg	200kg	200kg	200kg

**SWL 200kg** **1 YEAR WARRANTY**

ARTG - 364529

## MasterVest Gait Training Sling Mod.64



- Versatile training aid for toilet visits, standing, gait, and mobility training and standing positions
- Reduces strain on caregivers during physical training
- Easy transfers to and from toilet
- Lifts around the upper body and partly under the arms, best suited to patients who support some weight
- Leg harness for improved support (optional)

### MATERIALS

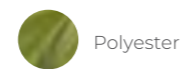

Polyester

### OPTIONAL



Leg harness

Leg Harness (Optional)			
Size	SML	MED/LRG	XL/XXL
Code	LSS394310	LSS394320	LSS394330
SWL	200kg	200kg	200kg

MasterVest Gait Training Sling						
Size	SML	MED	LRG	XL	XXL	
Code (Polyester)	LSS394260	LSS394270	LSS394280	LSS394290	LSS394300	
SWL	200kg	200kg	200kg	200kg	200kg	

**SWL 200kg** **1 YEAR WARRANTY**

ARTG - 362812

## LiftPants Gait Training Sling Mod.92



- Enables caregivers the ability to provide gait training
- To their parents while providing a sense of security for patients
- Offer freedom of movement while relieving the burden of body weight
- Provide necessary support to allow patient to move on his or her own with confidence
- Can be used on overhead or mobile patient lifters

### MATERIALS

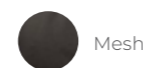

Mesh

Size	SML	MED	LRG	XL	XXL	XXXL
Code (Mesh)	LSS394340	LSS394350	LSS394360	LSS394370	LSS394380	LSS394390
SWL	200kg	200kg	200kg	500kg	500kg	500kg

**SWL 200kg** **SWL 500kg** **BARIATRIC** **1 YEAR WARRANTY**

ARTG - 365572

## Liko Accessories



Liko Scale



Liko SlingBar



Liko Stretch



Liko Clips

## A205 Aluminium Lifter



- Compact and versatile, ideal for high-use facility environments
- Ergonomic handset with Linak technology, intuitive control panel
- Powered leg function opens and closes the legs for lifting stability or accessibility
- One touch, quick release yoke with safety clips
- Release and attach mechanism, padded yoke for added patient safety
- Emergency stop button, emergency lowering, and anti-entrapment technology
- High quality castors - 2x 75mm front castors, 2x 100mm rear locking castors



Quick release yoke with safety clips

**SWL 205kg** **5 YEARS WARRANTY Frame** **3 YEARS WARRANTY Electronics** **1 YEAR WARRANTY Battery & Handset**

ARTG - 224748

Code	LSS390610
Overall Height	2045mm
Overall Length	1135mm
Overall Width	620mm - 1095mm
Lifter Weight	38.1kg
SWL	205kg

## A320 Aluminium Bariatric Lifter



- Heavy duty and manoeuvrable
- Emergency stop button, emergency lowering and anti-entrapment technology
- Ergonomic handset with Linak technology, intuitive control panel
- Powered leg function opens and closes the legs for lifting stability or accessibility
- Quick release 4 point yoke with one touch release and attach mechanism
- High quality castors - 2x 100mm front castors, 2x 125mm rear locking castors



Quick release yoke with safety clips



Ergonomic handset

**SWL 320kg** **BARIATRIC** **5 YEARS WARRANTY Frame** **3 YEARS WARRANTY Electronics** **1 YEAR WARRANTY Battery & Handset**

ARTG - 224625

Code	LSS390630
Overall Height	2165mm
Overall Length	1505mm
Overall Width	765mm - 1190mm
Lifter Weight	63kg
SWL	320kg

## Powered Pivot Frame



- Powered pivot frame minimises manual handling effort to achieve the full pivot range and positioning
- Patients can be ideally positioned for safety and comfort during the transfer process.
- Integrated power and control via lifter handset
- Four clip sling attachment points
- Designed for use with Aidacare Aspire Patient Lifters and Clip Slings

**SWL 227kg**

**5 YEARS WARRANTY**  
Frame

**3 YEARS WARRANTY**  
Electronics

<b>Code</b>	LSS390665
<b>Compatible Lifters</b>	A205, A320, 200
<b>Compatible Slings</b>	Aspire CLIP Slings
<b>SWL</b>	227kg

ARTG - 301226

## Manual Pivot Frame



- Finely balanced central pivot line requires minimal manual handling effort to achieve the full pivot range and desired positioning
- Four clip sling attachment points
- Allows a more comfortable user seating position and more control for the carer
- Designed for use with Aidacare Aspire Patient Lifters and Clip Slings

**SWL 227kg**

**5 YEARS WARRANTY**  
Frame

<b>Code</b>	LSS390670
<b>Compatible Lifters</b>	A205, A320, 200
<b>Compatible Slings</b>	Aspire CLIP Slings
<b>SWL</b>	227kg

ARTG - 301226

## In-Line Weigh Scale



- Designed to be fitted on Aidacare Aspire Patient Lifters, however adaptable to most lifter brands
- Allows for an accurate weight measurement to be taken by a carer when a patient is suspended in a sling
- Large weight capacity of up to 320kg
- Easy to read LCD display



Scale attached Quick Release Yoke

**SWL 320kg**

**2 YEARS WARRANTY**

<b>Code</b>	LSS390680
<b>Compatible Lifters</b>	A150F, A205, 200, A320
<b>SWL</b>	320kg

ARTG - 224748

## Deluxe General Purpose Sling



- Versatile sling offering body contoured fabric shaped for maximum patient comfort and support
- Sizing colour reference on edging of slings for easy visual identification
- For FIM score 1 or 2

### MATERIALS



### SIZING COLOURS



Body Contoured Fabric

**SWL 200kg**

**SWL 300kg**

**BARIATRIC**

**1 YEAR WARRANTY**

ARTG - 224718

Size	Loops (Polyester)	Loops (Mesh)	SWL
SML	LSS390700	LSS390716	200kg
MED	LSS390705	LSS390717	200kg
LRG	LSS390710	LSS390718	300kg
XL	LSS390715	LSS390719	300kg

## Deluxe General Purpose Sling with Head Support



- This sling has a comfortable padded head support with rigidisers for posture management
- Sizing colour reference on edging of slings for easy visual identification

### MATERIALS



### SIZING COLOURS

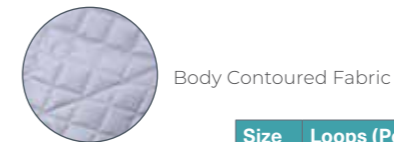

Body Contoured Fabric

**SWL 200kg**

**SWL 300kg**

**BARIATRIC**

**1 YEAR WARRANTY**

ARTG - 224718

Size	Loops (Poly)	Clips (Poly)	Loops (Mesh)	Clips (Mesh)	SWL
SML	LSS390740	LSS390900	LSS390756	LSS390916	200kg
MED	LSS390745	LSS390905	LSS390757	LSS390917	200kg
LRG	LSS390750	LSS390910	LSS390758	LSS390918	300kg
XL	LSS390755	LSS390915	LSS390759	LSS390919	300kg
XXL	LSS3907551	-	LSS3907591	-	300kg
XXXL	LSS3907552	-	LSS3907592	-	300kg

## Deluxe Hygiene Access Sling



- This sling offers generous underarm padding, quilted leg straps and a reinforced wide-cut back.
- Padded polyester fabric for increased patient comfort
- Sizing colour reference on edging of slings for easy visual identification
- Security strap features velcro and buckle fastening for easy positioning and added safety

### MATERIALS



### SIZING COLOURS



Security Strap

**SWL 200kg**

**SWL 300kg**

**BARIATRIC**

**1 YEAR WARRANTY**

ARTG - 224719

Size	Loops (Poly)	SWL
SML	LSS390760	200kg
MED	LSS390765	200kg
LRG	LSS390770	300kg
XL	LSS390775	300kg
XXL	LSS390776	300kg
XXXL	LSS390777	300kg



## Deluxe Hygiene Access Sling with Head Support



- Adjustable head support for additional patient safety and comfort.
- Padded poly fabric and generous under arm padding.
- Available in padded polyester or polyester with clips
- Security belt with velcro and buckle
- Sizing colour reference on edging of slings for easy visual identification
- For FIM score 2 or 3

### MATERIALS



### SIZING COLOURS



Size	Loops (Poly)	Clips (Poly)	SWL
SML	LSS390780	LSS390940	200kg
MED	LSS390785	LSS390945	200kg
LRG	LSS390790	LSS390950	300kg
XL	LSS390795	LSS390955	300kg



1 YEAR WARRANTY

ARTG - 224718

## Deluxe Standing Sling

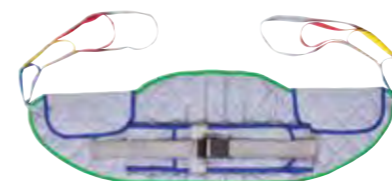

- Generous underarm padding and reinforced wide-cut back for comfort
- Quilted and padded under arm and on back to enhance patient comfort, stability and rigidity
- Security strap with velcro and buckle fastening for easy positioning and added safety.
- Sizing colour reference on edging of slings for easy visual identification
- For FIM score 3 or 4

### MATERIALS



### SIZING COLOURS



Size	Loops (Poly)	Clips (Poly)	SWL
SML	LSS390720	LSS390920	200kg
MED	LSS390725	LSS390925	200kg
LRG	LSS390730	LSS390930	300kg
XL	LSS390735	LSS390935	300kg
XXL	LSS390736	-	300kg
XXXL	LSS390737	-	300kg



1 YEAR WARRANTY

ARTG - 224698

## Deluxe Hammock Sling with Head Support



- Full body sling for high needs patients
- Mesh for general use or Supersoft for long periods of use
- Parasilk leg strap lining for easy positioning
- Sizing colour reference on edging of slings for easy visual identification
- For FIM score 1 or 2

### MATERIALS



### SIZING COLOURS



Size	Loops (Mesh)	Loops (Supersoft)	SWL
SML	LSS390860	LSS390800	200kg
MED	LSS390865	LSS390805	200kg
LRG	LSS390870	LSS390810	300kg
XL	LSS390875	LSS390815	300kg

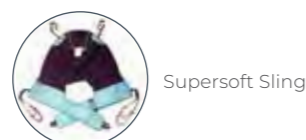

1 YEAR WARRANTY

ARTG - 224720

## Single Use Patient Sling



- General Purpose Sling with Head Support designed for single and exclusive patient use, to reduce risk of cross contamination between users
- Strong and durable non-woven fabric for a comfortable and safe lift
- ID tag for patient's name to help control exclusive use
- Intuitive usage indicator identifies when sling has been wet or washed, rendering it unusable
- Coloured binding identifies sling size
- Sold in packs of 5

### MATERIALS



### SIZING COLOURS



Size	Loops (Non Woven)	SWL
SML	LSS391100	200kg
MED	LSS391110	200kg
LRG	LSS391120	200kg
XL	LSS391130	200kg



ARTG - 224718

## Deluxe Low Friction Parasilk Sling



- Parasilk material is low friction for easy positioning
- Supports the whole body and is suitable for general transfers, including seated to seated and bed to chair transfers
- Sizing colour reference on edging of slings for easy visual identification
- For FIM score 1 or 2

### MATERIALS



### SIZING COLOURS



Size	Loop (Parasilk)	Clips (Parasilk)	SWL
SML	LSS390880	LSS390960	200kg
MED	LSS390885	LSS390965	200kg
LRG	LSS390890	LSS390970	300kg
XL	LSS390895	LSS390975	300kg



ARTG - 224719 - Loops | ARTG - 224718 - Clips

## Hybrid Sling with Head Support & Hygiene Access



- Hybrid design combines general purpose sling and hygiene sling design for versatility
- Padded head support with rigidiser for posture management
- Body contoured fabric shaping for maximum patient comfort and support
- Wider bottom cut-out provides easy removal of clothing or toilet transfers
- Easy clean – machine washable up to 85°C

### MATERIALS



### SIZING COLOURS



Size	Loops (Non Woven)	SWL
SML	LSS390830	200kg
MED	LSS390835	200kg
LRG	LSS390840	300kg
XL	LSS390845	300kg



ARTG - 224718



## STAR Patient Mover



- Wide seat entry to suit range of users
- Low footplate height for easy entry/exit
- Large 100mm castors (two rear locking) have low rolling resistance for a smooth ride during transportation
- Narrow base for access in tight spaces
- Height adjustable knee support ensures correct positioning range of patients
- Easy access seat pad handles provide reach-around access to carers
- Soft touch grab bar for comfort and stability during transfers
- Width adjustable legs with tapered close position allow access between and, or around chair legs

Code	LSS390580
Overall Length	925mm
Overall Height	1033mm
Overall Width	615mm - 900mm
Knee Pad Height	205 - 495mm
Seat Pad Height	685mm - 850mm
Handle Height	1030mm
Min External Leg Width	520mm
Max Internal Leg Width	740mm
Footplate Height from Floor	60mm
SWL	185kg

SWL 185kg **2 YEARS WARRANTY**

ARTG - 265455

## Evacuation Sheet



- Fits discreetly underneath the resident's mattress secured by cross and corner straps
- Allows bed making to occur as normal
- Pulling straps located at head and foot ends
- Remains readily accessible in case of emergency evacuation
- Fire retardant and highly durable, low friction surface
- Suitable for use by one or two carers



Pulling Straps

Code	TSE672526 - Universal
Length	1900mm
Width	900mm
SWL	300kg

SWL 300kg **1 YEAR WARRANTY**

## Slide Sheet



- Nylon material designed to assist in sliding and transferring patients
- Low friction fabric slides on itself to facilitate patient bed mobility
- High quality Nylon fabric and stitching for improved durability
- Aspire slide sheets can be laundered for ongoing patient hygiene

### MATERIALS

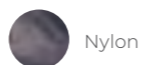

Nylon

Size	Small	Large
Code	TSE673070	TSE673080
Length	1000mm	2000mm
Width	1450mm	1450mm

**1 YEAR WARRANTY**

ARTG - 156965

## Non-Slip One Way Slide



- Non-slip mesh grips securely to smooth surfaces such as vinyl upholstery
- Soft seating surface can remain under patient throughout the day and facilitate multiple repositions
- Foot strap threads through back of the chair to assist the carer with effortless positioning into seat
- Machine washable

**1 YEAR WARRANTY**

ARTG - 156965

Code	TSE673050
Length	440mm
Width	450mm

## Foot Operated One Way Slide



- Non-slip mesh grips securely to smooth surfaces such as vinyl upholstery
- Soft seating surface can remain under patient throughout the day and facilitate multiple repositions
- Foot strap threads through back of the chair to assist the carer with effortless positioning into seat
- Machine washable



Foot Strap Threads

**1 YEAR WARRANTY**

ARTG - 156965

Code	TSE673052
Length	1300mm
Width	450mm

## Positioning Slide - Foot Operated



- Designed with care staff in mind, low friction surfaces allow for easy patient manoeuvring with minimal lift
- For patients with a lower risk of slipping while sitting in a chair
- Manoeuvre the patient easily to the back of the chair or sideways for transfer assistance
- Foot strap threads through back of chair to assist the carer with positioning
- Machine washable

**1 YEAR WARRANTY**

ARTG - 156965

Code	TSE673054
Length	1375mm
Width	460mm

## Swivel Cushion



- Low friction pivot allows easy sit and swivel entry and exit from vehicles
- Minimises exertion and the likelihood of injury, and improves the angle of access to or from mobility equipment
- Plush velour fabric and generous padding for maximum comfort on long car trips
- Machine washable

### MATERIALS



Plush Velour Fabric

**1 YEAR WARRANTY**

ARTG - 156965

Code	TSE673056
Width	440mm

# Patient Handling: Ceiling Systems

---

Ceiling hoists are ideal for transferring patients within a hospital setting. Designed for use by those with limited mobility, these items of equipment can aid nurses and staff in their care and handling of patients. Unlike standing styles, ceiling lifts are secured to the roof. Utilising gantries and tracks, they are able to hoist and move patients around hospital rooms.

The Aidacare selection of ceiling hoists includes high-quality options that provide the utmost support and safety. Our products are able to gently and easily move patients while eliminating potential strains and injuries for staff. Our wide range of motor and track options allows us to cater to many needs.

As well as distributing ceiling hoist systems, we also provide expert advice and installation through our network of Aidacare and partner locations.

# Ceiling Hoist Considerations

We understand the risks involved in the installation and use of ceiling hoists so we can help during early-stage specification and design to reduce risk and improve user-acceptance.

Our systems are world-class and are accompanied by accredited installation guidelines which allow us to work with a range of installers. We are an ISO 9001 accredited company and consistently provide high-quality outcomes for Australia's largest aged care and hospital providers.

We have a wide range of motor and track options available to suit client specifications

Some common examples are provided below:

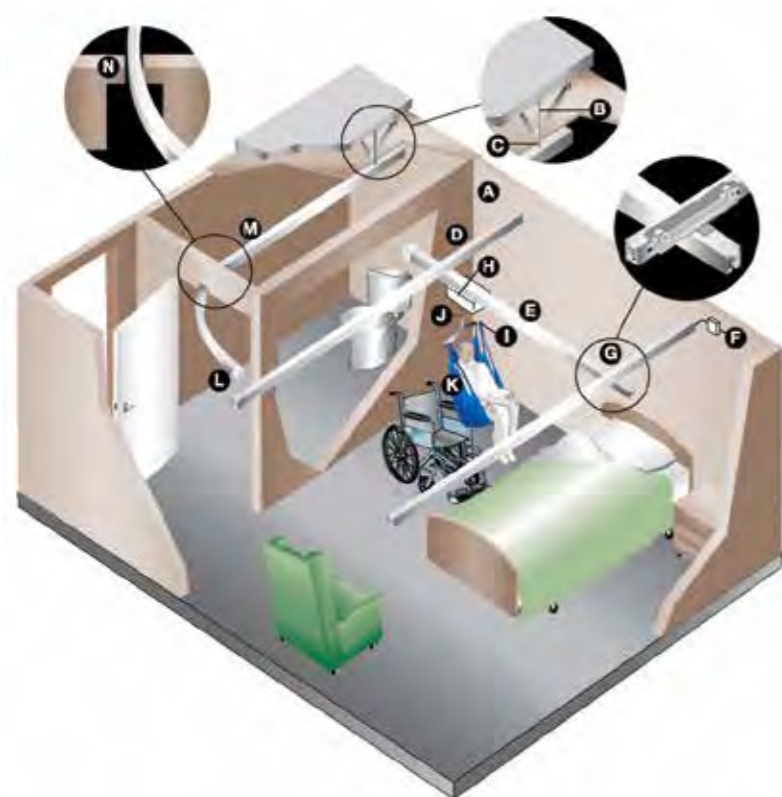

- A. Structural Attachment Point
- B. Threaded Rod
- C. Ceiling Bracket
- D. Ceiling Track
- E. Traverse Boom (Track)
- F. Charging Station
- G. X-Y Gantry
- H. Ceiling Lift Unit
- I. Carry Bar
- J. Lift Strap
- K. Sling
- L. Gait Assembly
- M. Linear Track
- N. Modified Door Header

## Consulting Solution

No two installations are alike. We deal with many different installation substrates and scenarios. Aidacare utilises manufacturer-certified installation guidelines. Some of the more complex examples are shown below. This leads to a consistent high-quality outcome for our clients.

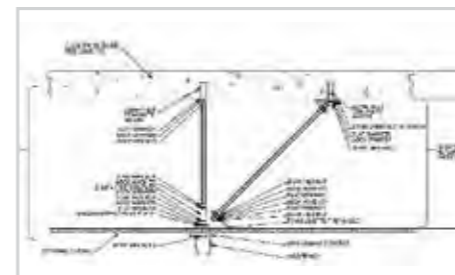

Concrete with Supports

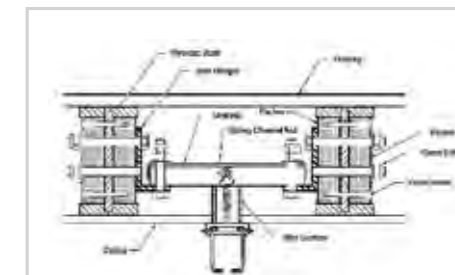

Complex Timber Joists

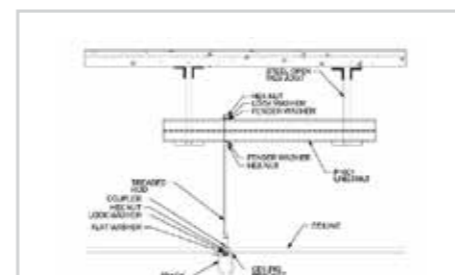

Hanging Ceiling

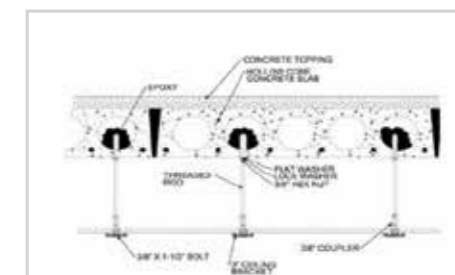

Hollow-Core Concrete

**Maintenance Safety:** Aidacare fully-supports its installations with ongoing maintenance programs. We also assist our clients to develop their own internal maintenance regime.

**Training and User Acceptance:** Our Equipment Specialists offer user training and ongoing support. We also provide WHS signage with all equipment.

**Quality and Compliance:** All systems are tested and installed in compliance with Australian Standard AS/NZ ISO 10535-2011 Hoists for the transfer of disabled persons. All systems are maintained in accordance with manufacturer's guidelines and in accordance with AS/NZ 3551-2012 Management Programs for Medical Equipment.

Aidacare is an ISO9001 compliant company. Aidacare uses an accredited network of trained installers, engineers, and load testers

## Consulting Solution

Aidacare has extensive experience with installation and user-acceptance of ceiling systems. Simple things can be identified during planning to reduce risk in the installation and improve user and patient outcomes. We can assist in developing the best solution.

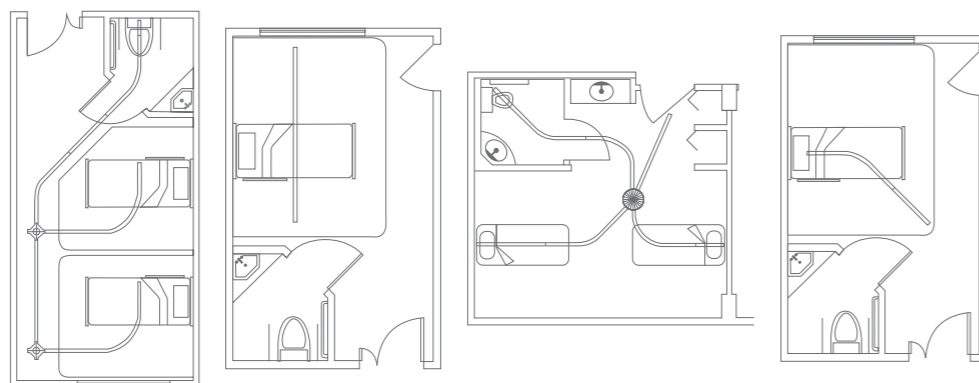

Linear

Straight Monorail

Turntable

J Track

## Track Options



Exposed Track

Concealed Track

Concealed Track

45° Curve Track

90° Curve Track

Quick Curve

## Ceiling Hoist Accessories

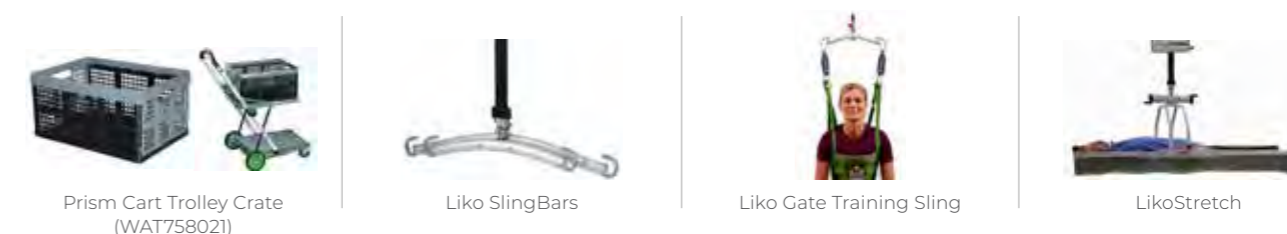

Prism Cart Trolley Crate (WAT758021)

Liko SlingBars

Liko Gate Training Sling

LikoStretch



## CP200 Portable Ceiling Hoist



- Hoist can be reversed to act as a portable or fixed unit
- Slimline, low profile, padded carry bar has six loop attachments as standard (four-point hook optional). Different width carry bars also available
- Unobtrusive low profile hoist provides greater lifting height
- All lifting and traversing operations have soft start / stop to ensure smooth transfers for the patient
- A host of safety features
- Smooth running tape with large lifting range
- State of the art display with lift counter
- Ergonomically designed handset with hold to run buttons and directional arrows requires minimum pressure to operate. Pneumatically controlled, safe for use in wet conditions
- Fire retardant cover completely encapsulates hoist
- Neat in track transformer, IP 67 rated
- Coloured direction indicators on hoist unit match hand control to ensure correct operation first time
- Emergency stop and manual emergency window

Exclusively distributed by Aidacare

**SWL 200kg** **1 YEAR WARRANTY**

<b>Code</b>	LIC350105
<b>Height Range</b>	Up to 2100mm
<b>Weight</b>	4.5kg
<b>SWL</b>	200kg

ARTG - 286310

## Transactive Xtra Ceiling Hoist



- Large array of configurations to suit changing needs
- Digital display screen provides essential information
- Automatic Return to Charge (RTC) option
- Manual wind down and raising for use during a power outage
- Unobtrusive low profile hoist provides greater lifting height
- Pneumatic handset is ideal for use in wet environments
- Smooth lifting/running tape with large lifting range
- Emergency lowering allows for the safe lowering of the in emergency situations
- Client safety is assured with locking latches to secure slings in place for all lifts

Exclusively distributed by Aidacare

Manual (9.7kg)	SWL (kg)	Height Range	Powered (10.4kg)	SWL (kg)	Height Range
LIC350130	130	Up to 2080mm	LIC350140	130	Up to 2080mm
LIC350150	160		LIC350160	160	
LIC350170	200		LIC350180	200	
LIC350200	270		RTC LIC350190	200	
Curtain Jumper LIC350220	270		LIC350210	270	
-	-		RTC LIC350240	270	
-	-		Curtain Jumper LIC350230	270	

**1 YEAR WARRANTY**

ARTG - 286310

## C380 Bariatric Fixed Ceiling Hoist



- The C380 is specifically designed to lift clients that exceed a standard hoist's maximum weight capacity
- As the strongest ceiling track hoist in its class, the C380 safely transfers bariatric clients with respect and dignity
- Low profile hoist unit is unobtrusive and provides greater lifting height
- Digital display screen provides essential information for the user and caregiver
- Automatic Return to Charge (RTC) option
- Pneumatic handset is ideal for use in wet environments
- Smooth lifting/running tape with large lifting range
- Emergency lowering allows for the safe lowering of the in emergency situations
- Client safety is assured with locking latches to secure slings in place for all lifts

Exclusively distributed by Aidacare

**SWL 380kg** **BARIATRIC** **1 YEAR WARRANTY**

ARTG - 286310

<b>Code</b>	Manual Traverse - LIC350250
	Powered Traverse - LIC350260
	Powered Traverse & RTC LIC350270
<b>Height Range</b>	Up to 2080mm
<b>Weight</b>	10.4kg
<b>SWL</b>	380kg

## LikoGuard L/XL Fixed Ceiling Hoist



- Combines powerful performance and enhanced safety features
- Newly designed 450 SlingGuard sling bar encourages the correct placement of sling loops for greater confidence in safe patient mobilisation
- Innovative emergency stop and manual emergency lowering mechanism that is easy to reach, engage, and operate with no tools, ladder, or force needed
- Two choices of IPX7 certified hand controls, one LED and one LCD backlit display. Both easy-to-use hand controls features battery, service and overload-indication. Advanced and intuitive LCD hand control offers graphical user interface with tracking of user and service data
- The LikoGuard lift system offers lift intervals of 230cm and supports quick release hooks, fixed sling bars and stretchers
- Choice of on-wall or in-rail charger

Exclusively distributed by Aidacare

**SWL 272kg** **SWL 363kg** **BARIATRIC** **10 YEARS WARRANTY Frame** **2 YEARS WARRANTY Electrical Parts**

ARTG - 354052

<b>Code</b>	LIC359300	LIC359310
<b>Size</b>	Large	X-Large
<b>Height Range</b>	Up to 2300mm	Up to 2300mm
<b>Weight</b>	14kg	14kg
<b>SWL</b>	272kg	363kg

## Multirall 200 Portable Ceiling Hoist



- The Multirall 200 hoist is a portable ceiling hoist that can also be used for room-to-room patient transfers
- Can be used to transfer a patient between rooms in a sitting position, easily moving from one rail system to another with the use of a transfer strap
- It's portability makes it an excellent and economical solution for nursing home and hospital care situations where lifting needs are temporary
- Can be easily attached or removed with no tools and minimum effort from ceiling rails to facilitate convenient transport between rooms
- Quick sling bar change thanks to Q-link and Quick-release Hook
- Can be mounted two ways for ease of use

Exclusively distributed by Aidacare

**SWL 200kg**

**10 YEARS WARRANTY**  
Frame

**2 YEARS WARRANTY**  
Electrical Parts

<b>Code</b>	LIC359100
<b>Height Range</b>	Up to 1600mm
<b>Weight</b>	8.7kg
<b>SWL</b>	200kg

ARTG - 354052

## Likorall 200 Fixed Ceiling Hoist



- The Likorall 200 is an economical fixed ceiling hoist needed to manage everyday lifting situations
- The patented safety drum with speed limiter facilitates electrical emergency lowering
- Ideal for floor lifts in most environments
- Can be equipped with a special carriage for planned transfers between different rooms
- Ergonomically designed hand control
- Quick sling bar change thanks to Q-link and Quick-release Hook
- Simple wall charging via hand control

Exclusively distributed by Aidacare

**SWL 200kg**

**10 YEARS WARRANTY**  
Frame

**2 YEARS WARRANTY**  
Electrical Parts

<b>Code</b>	LIC359490
<b>Height Range</b>	Up to 1800mm
<b>Weight</b>	8.7kg
<b>SWL</b>	200kg

ARTG - 354052

## Likorall 242 Fixed Ceiling Hoist



- The Likorall 242 ceiling hoist is designed to meet demanding lifting requirements
- The system is an ideal choice for those who want to move the lift motor along a track electronically with a transfer motor, or to control the system with a wireless hand control option
- The patented safety drum with speed limiter facilitates electrical emergency lowering
- Can be equipped with a special carriage for planned transfers between different rooms
- Wireless hand control
- Quick sling bar change thanks to Q-link and Quick-release Hook
- Simple wall charging via hand control or in rail charging

Exclusively distributed by Aidacare

**SWL 200kg**

**10 YEARS WARRANTY**  
Frame

**2 YEARS WARRANTY**  
Electrical Parts

<b>Code</b>	Likorall 242 Manual - LIC359535
	Likorall 242 Powered Room to Room - LIC359500
	Likorall 242 Manual Room to Room - LIC359510
<b>Height Range</b>	Up to 2000mm
<b>Weight</b>	8.7kg
<b>SWL</b>	200kg

ARTG - 354052

## Likorall 250 Fixed Ceiling Hoist



- The Likorall 250 ceiling hoist is designed to meet demanding lifting requirements
- The system is an ideal choice for those who want to move the lift motor along a track electronically with a transfer motor, or to control the system with a wireless hand control option
- The patented safety drum with speed limiter facilitates electrical emergency lowering
- Can be equipped with a special carriage for planned transfers between different rooms
- Wireless hand control
- Quick sling bar change thanks to Q-link and Quick-release hook
- Simple wall charging via hand control or in rail charging

Exclusively distributed by Aidacare

**SWL 250kg**

**10 YEARS WARRANTY**  
Frame

**2 YEARS WARRANTY**  
Electrical Parts

<b>Code</b>	Likorall 250 Powered - LIC359520
	Likorall 250 Manual - LIC359530
<b>Height Range</b>	Up to 1800mm
<b>Weight</b>	8.7kg
<b>SWL</b>	250kg

ARTG - 354052





## Layson

MOTomed



- Provides passive, motor-assisted and active training of the lower extremities for patients in intensive care units, critical care, early rehabilitation and dialysis
- Easily and effortlessly adapted to the individual needs
- Flexibly moved to the patient's bed and positioned
- 4-point ground fixation enables a stable stand
- Plastic-coated safety foot shells with disinfectable fastening straps (pair, including pedal cranks)
- Gas spring support for height adjustment
- Selectable parallel chassis or expandable chassis with ground fixation
- Knee bending adjustment including adjustment wheel
- Colour touch display (7"), rotatable, inclinable (basic equipment with fixed operating panel)
- Pedal radius: 7cm
- Sturdy metal construction, high quality and stable with closed plastic body (PC/ABS), easy to clean/disinfect
- Easily movable with large castors (Ø 7.5cm)
- Patient remote control

Code	FPM101150
Length	1100 - 1250mm
Width	620 - 1000mm
Height	1130 - 1570mm
Unit Weight	80kg
SWL	135kg

SWL  
135kg

MOTomed

## Muvi



- Passive or active training, movement speed, and the resistance level for legs and arms can be adjusted separately for simultaneous movement
- Simultaneous or independent leg and arm training which can improve effectiveness of therapy
- Trainer can be upgraded to an FES Cycle with the HASOMED RehaMove2 'Functional Electrical Stimulator'
- Electronic foot insertion aid
- Speed from 1 to 60 rpm (passive), resistance from 0 to 20 (active), motor power from 1 to 10 (passive)
- Presetting of therapy time from 0 to 120 minutes
- Movement protection and spasm control, safety stop
- Symmetry training of leg and arm/upper body trainer
- Quiet, gentle and harmonious cycle movement
- Gentle starting and stopping of the movement
- Therapy, training and motivation programs
- Detailed biofeedback during and after training
- Export of training data, import of training programs

Code	FPM101100
Length	950 - 108mm
Width	600mm
Height	1240 - 1350mm
Unit Weight	51kg
SWL	135kg

SWL  
135kg

## Loop LA

MOTomed



- Passive active trainer can be quickly and easily switched from arm to leg training
- Tool free height adjustment of leg or arm/upper body
- Colour touch display (7"), retractable and inclinable
- Easily movable with large transport rollers (Ø 13cm)
- Closed plastic body (PC/ABS), easy to clean/disinfect
- Plastic-coated safety foot shells with Velcro fastening
- Soft Grip handles
- 2-stage pedal radius adjustment (7cm or 12.5cm)
- Leg trainer pedal axle height adjustable 30-45cm
- Arm trainer pedal axle height adjustable 90-105cm
- Reduced height stand for complex use footplate
- Therapy and motivation program, training programs, and games
- Slideshow via USB (delivered without USB stick)
- Serial interface, USB interface.

Code	FPM101130
Length	700mm
Width	600mm
Height	1070 - 1220mm
Unit Weight	36kg
SWL	135kg

SWL  
135kg

HASOMED

## RehaMove2



Can be attached to Motomed products for: Motion Training with Functional Electrical Stimulation (FES)

- Portable electrical stimulation device that generates impulses on up to 8 channels simultaneously to activate impaired/paralyzed muscles via surface electrodes
- Relieves muscle spasms, prevent or avoid atrophy due to immobilization, increase the local blood flow or increase respectively maintain the range of motion
- Designed for use in a specific rehabilitation system using an ergometer for FES Cycling
- Big graphical display, pressure-sensitive buttons, and a rotary switch
- Numerous parameters for power and temporal sequence of the impulses can be adjusted individually
- RehaMove2 is designed as portable (contains a battery) as well as stationary device for training and rehabilitation applications
- Tapping [Stop] on the screen or pressing the Quick-Stop button stops the movement and stimulation immediately. Electrode error detection function stops the device in case of faulty electrodes or other errors
- Certified according to the international standards EN 60601-1 and EN 60601-2-10 for medical technical devices and systems

Code	FMP100185
------	-----------



# Dual Beam Bed Monitor

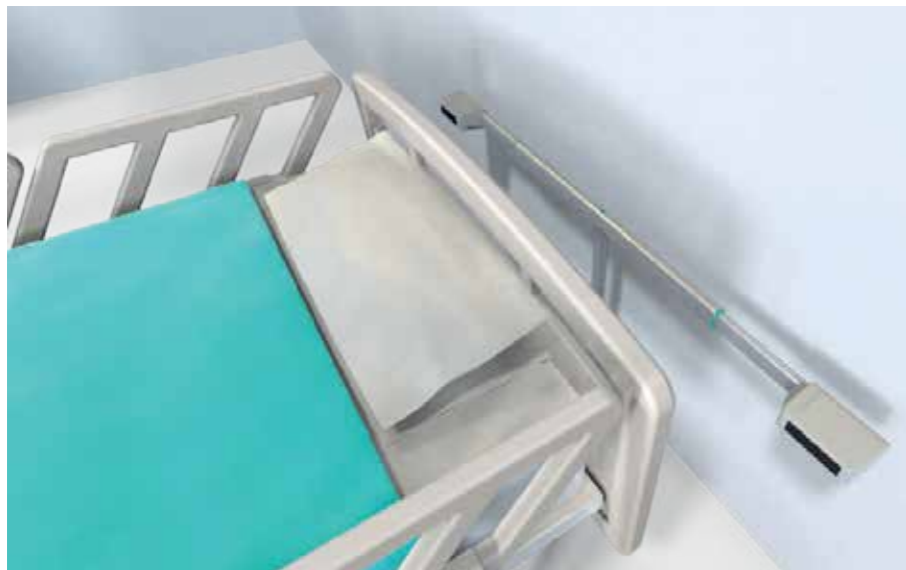

## INMISA-BEAM

### OPTIONAL ACCESSORIES

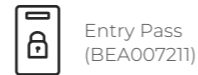

Entry Pass (BEA007211)

The Entry Pass is like a master key. It allows the nurse free access to the patient without worrying about switches.

When the nurse attends to the patient in response to an alarm:

- The Entry Pass cancels the alarm
- The bed monitor alarms automatically resets when the nurse leaves the bed

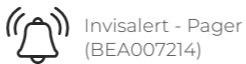

Invisalert - Pager (BEA007214)

INVISALERT allows the nurse free access to the patient without worrying about switches.

Displays the location of the alarm source – bed and room

Vibrating alarm  
Audible alarm

When the nurse attends to the patient in response to an alarm:

- INVISALERT cancels the alarm
- The bed monitor alarms automatically resets when the nurse leaves the bed

### APPLICATIONS

- Hospitals
- Aged Care Facilities
- Nursing Homes
- High Care

**2 YEARS WARRANTY**

Code	Product
BEA007216	Dual Beam Monitor w/ Mono & Stereo
BEA007217	Dual Beam Monitor w/ Remote Alarm
BEA007218	Dual Beam Monitor w/ Invisalert
BEA007212	5 Card Charger
BEA007255	3.7V Rechargeable Battery Pack
BEA007256	Power Supply Charger
BEA007209	Dual Beam - CPU *Fits all Invisa-beam products
BEA007210	Range Extender *Fits all Invisa-beam products
BEA007215	Remote with Power Supply *Fits all Invisa-beam products

### Features and Benefits

- Monitors both sides of the bed with precise invisible beams
- Alerts the nurse at the earliest stage, when the patient attempts to leave the bed
- Alerts the staff of any unauthorised entry to the bed
- Monitor alarm cancels when the nurse enters the bed's field
- Monitor alarm automatically resets when the nurse leaves
- Monitors both sides of the bed with precise invisible beams
- Total wireless operation
- Bed free of equipment and cables
- Hands-free – a bonus for infection control
- Activity at the bedside can be recorded
- Can be used for lowered beds; also for bariatrics
- Invisa-beam® uses heavy duty, industrial German sensors

ARTG - 173590

# DIALABEAM Monitor

## INMISA-BEAM



**2 YEARS WARRANTY**

ARTG - 173590

- This is a 2 in 1 monitoring system
- Monitors the width of the chair or the length of the bed, also useful for doorways and bathrooms
- Power or battery operated
- The height is adjustable.

Code	Product
BEA007225	Monitor w/ Mono & Stereo Plug
BEA007226	Monitor w/ Remote Alarm
BEA007227	Monitor w/ Invisalert

# Free-Standing Monitor

## INMISA-BEAM



**2 YEARS WARRANTY**

ARTG - 173590

- Free-standing bed monitor stands at head of bed to monitor side of bed
- Power operated
- The height is adjustable for lowered beds

Code	Product
BEA007220	MPM Bed Monitor w/ Mono & Stereo Plug
BEA007221	MPM Bed Monitor w/ Remote Alarm
BEA007222	MPM Bed Monitor w/ Invisalert

# Bed Monitor

## INMISA-BEAM



**2 YEARS WARRANTY**

ARTG - 173590

- Attached to the bed head to monitor the side of the bed
- It monitors the length of the bed with precise, invisible beams
- Power operated

Code	Product
BEA007200	Bed Monitor w/ Mono & Stereo Plug
BEA007201	Bed Monitor w/ Remote Alarm

# Chair Monitor

## INMISA-BEAM



**2 YEARS WARRANTY**

ARTG - 173590

- Uses invisible beam to monitor defined distance in front of chair
- Portable and battery operated
- Used with remote alarm or pager
- Align the sensor in front of the chair or across a doorway

Code	Product
BEA007204	Chair Monitor w/ Remote Alarm
BEA007205	Chair Monitor w/ Pager
BEA007206	Chair Monitor Battery Charger



## Bed Pad



- Bed pad alarm system activates when a resident or patient falls or gets out of a bed or chair
- Re-arms itself if the resident / patient gets back onto the sensor pad
- Anti allergic soft PVC construction for optimum comfort

**1 YEAR WARRANTY**

Code	Product
BEA007422	Cura Bed Pad

ARTG - 205007

## Premium Bed Pad



- Works with all Cura Alarms
- Easy to clean
- Ventilated neck prevents moisture build up
- Non-allergenic soft PVC
- Compatible Monitors included:
  - Recordable voice monitor
  - Safety reset bed monitor

**1 YEAR WARRANTY**

Code	Product
BEA007412	Premium Bed Pad - Long
BEA007414	Premium Bed Pad - Short

ARTG - 205007

## Cordless Bed Pad



- Wireless bed pad alarm system removes tripping hazards
- Can connect to nurse call system
- Simple operation and maintenance
- Adjustable volumes and tones
- Also works w/ premium bed/chairs pads

**1 YEAR WARRANTY**

Code	Product
BEA007432	Cordless Bed Pad

ARTG - 205007

## Deluxe Floor Alertamat



- Plush carpet floor mat is a safe falls prevention solution that suits modern care environments
- Distinguished look is an ideal solution for situations where a patient with dementia would otherwise avoid the mat
- A robust, long life floor alarm with simple plug and play set up
- Long lasting welded seams for durability
- Large size to prevent overstepping by the user

**1 YEAR WARRANTY**

ARTG - 306083

Code	Product	Length	Width
BEA007615	Deluxe Floor Alertamat System (includes mat, monitor)	900mm	600mm
BEA007616	Wireless Deluxe Floor Alertamat System (includes mat, monitor)		
BEA007570	Wireless Deluxe Floor Alertamat System (includes mat, monitor)		
BEA007618	Wireless Deluxe Floor Alertamat		

## Floor Plus Alertamat



- Heavy duty floor mat provides a safe falls prevention solution with maximum longevity
- Simple plug and play so carer can quickly set up and operate with ease
- A robust, long life floor alarm
- Long lasting welded seams for durability
- Large size to prevent overstepping by the user
- Hygienic, anti-bacterial easy-clean material

**1 YEAR WARRANTY**

ARTG - 306083

Code	Product	Length	Width
BEA007620	Floor+ Alertamat System (includes mat, monitor & cables)	800mm	550mm
BEA007621	Floor+ Alertamat		
BEA007575	Wireless Floor+ Alertamat System (includes mat, monitor)		
BEA007621	Wireless Floor+ Alertamat		

## Bed Alertamat



- Warns of falls risk if patient leaves / tries to leave bed
- Simple plug and play for easy set up and operation
- High and low volume alert, multiple alarm tones
- Adjustable delay to reduce false alarms
- Alarm automatically resets when patient returns
- Hygienic, antibacterial easy-clean material
- System includes: bed pad, alarm monitor, stereo and mono nurse call cables

**OPTIONAL:**

Main Powered  
 Battery Powered

**1 YEAR WARRANTY**

ARTG - 306083

Code	Product	Length	Width
BEA007605	Bed Alertamat System (includes pad, monitor & cables)	760mm	250mm
BEA007565	Wireless Bed Alertamat System (includes pad, monitor & cables)		
BEA007662	Wireless Bed Alertamat (Mat Only)		

## Chair Alertamat



- Alerts carers if patient leaves or attempts to leave chair, helping to manage falls risk
- Simple plug and play ensures carer can quickly set up and operate with ease
- High and low volume alert
- Multiple choice alarm tone
- Adjustable delay to reduce false alarms
- Alarm is reset automatically when patient returns to the chair
- Hygienic, antibacterial easy-clean material
- System includes: chair pad, alarm monitor, stereo and mono nurse call cables



**OPTIONAL:**

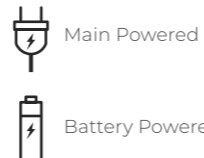

Code	Product	Length	Width
BEA007600	Chair Alertamat System (includes pad, monitor & cables)	380mm	250mm
BEA007560	Wireless Chair Alertamat System (includes pad, monitor)		
BEA007657	Wireless Chair Alertamat (Mat Only)		



ARTG - 306083

## Alerta Detect Infrared System



Receiver



Sensor



- Infrared beam senses when a patient leaves their bed, alerting carers to minimise potential falls risk
- Can also be used to allow the patient to move around their room freely, only alerting carers if they leave their room
- Can be used as a standalone system (sensor and receiver via infrared 'IR') to create an alarm within the room or directly placed into nurse call system (sensor only)
- Wireless plug and play ensures carer can quickly set up and operate with ease
- System includes: sensor and receiver, stereo and mono nurse call cables
- Wireless solution that removes excess cables and provides a streamline falls prevention solution
- Large sensor range of up to 95m ensures all types of room configurations are covered
- Can be battery operated (sold separately) or via a mains power cable (optional accessory)
- Receiver can be carried around in the homecare space by a carer, fitting neatly into the pocket

**OPTIONAL:**

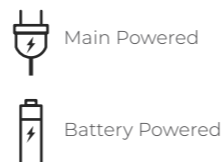

Code	Product
BEA007610	Alerta Detect Infrared System
BEA007670	Alerta Detect Receiver
BEA007675	Alerta Detect Sensor



ARTG - 306083

## Accessories and Plug Identification

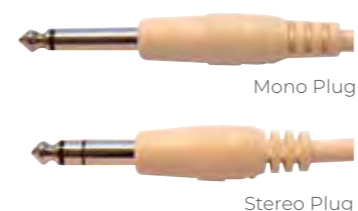

Most nurse call systems take one of the following plug types: Mono and Stereo cables are the most common connection types in nurse call systems in Australia. Alerta alarm systems are supplied with both mono and stereo cables when purchased as a system, to ensure there is no delay upon installation.

If you require further assistance please contact: [sales@aidacare.com.au](mailto:sales@aidacare.com.au)

A. Alarm Monitor



B. Mains Power Cable



C. Double Adapter



D. Extension Cable



E. Single Cable



F. AlertaCall Nurse Button



G. Dual Cable



## Accessories Product Codes

	Code	Product
A	BEA007665	Alarm Monitor
B	BEA007680	Mains Power Cable
C	BEA007635	Double Adapter - Mono
	BEA007640	Double Adapter - Stereo
D	BEA007645	Extension Cable - Mono
	BEA007650	Extension Cable - Stereo
E	BEA007690	Mono Cable
	BEA007685	Stereo Cable

	Code	Product
F	BEA007625	AlertaCall Nurse Call Button - Mono
	BEA007630	AlertaCall Nurse Call Button - Stereo
G	BEA007700	Dual Mono Cable
	BEA007695	Dual Stereo Cable
H	BEA007705	Floor Mat to Alarm Cable
I	BEA007691	Ring/Sleeve Cable
J	BEA007692	Tip Ring Cable

ARTG - 306083





## Emergency Crash Cart



- The Aidacare Emergency Crash Cart has sleek lines, and strong construction
- Smooth manoeuvrability will make it the choice in emergency departments
- The simple breakaway lock offers easy access, combined with essential security
- Carts come standard with all essential accessories, to enhance the user experience
- Customisation to suit a range of applications
- Comprehensive range of standard accessories available

\* Three drawer sizes available: 3" (7cm), 6" (16cm) and 9" (25cm)

### LOCK TYPE



Breakaway

**5 YEARS WARRANTY**  
Structural

**1 YEAR WARRANTY**  
Accessories

Code	Size	Height	Length	Width	Drawers
WAT909400	S	90cm / 8H	61cm	79cm	3x 3", 1x 6", 1x 9"
WAT909410	M	100cm / 9H			2x 3", 2x 6", 1x 9"
WAT909420	L	110cm / 10H			3x 3", 2x 6", 1x 9"

## Medication Cart



- A powerful all-rounder for applications including Treatment, Procedure, IV, Trauma, Dressing, Supply and General cart
- Work surface and drawer dividers
- Fully customisable, accessories, and drawer configurations
- Sleek lines, strong construction and smooth manoeuvrability

\* Three drawer sizes available: 3" (7cm), 6" (16cm) and 9" (25cm)

### COLOUR OPTIONS



### LOCK TYPE



Breakaway Digital Key

**5 YEARS WARRANTY**  
Structural

**5 YEARS WARRANTY**  
Digital Lock

**1 YEAR WARRANTY**  
Accessories

Code	Description	Size	Height	Length	Width	Drawers
WAT909510	Digital Lock - Cream	S	90cm / 8H	61cm	79cm	1x 3", 2x 6", 1x 9"
WAT909540	Digital Lock - Cream	M	100cm / 9H			2x 3", 2x 6", 1x 9"
WAT909550	Digital Lock - Cream	L	110cm / 10H			1x 3", 3x 6", 1x 9"
WAT909430	Digital Lock - Blue	S	90cm / 8H			1x 3", 2x 6", 1x 9"
WAT909450	Digital Lock - Blue	M	100cm / 9H			2x 3", 2x 6", 1x 9"
WAT909460	Digital Lock - Blue	L	110cm / 10H			1x 3", 3x 6", 1x 9"
WAT909560	Key Lock - Cream	S	90cm / 8H			1x 3", 2x 6", 1x 9"
WAT909590	Key Lock - Cream	M	100cm / 9H			2x 3", 2x 6", 1x 9"
WAT909600	Key Lock - Cream	L	110cm / 10H			1x 3", 3x 6", 1x 9"
WAT909470	Key Lock - Blue	S	90cm / 8H			1x 3", 2x 6", 1x 9"
WAT909490	Key Lock - Blue	M	100cm / 9H	2x 3", 2x 6", 1x 9"		
WAT909500	Key Lock - Blue	L	110cm / 10H	1x 3", 3x 6", 1x 9"		

## Paediatric Crash Cart



- Designed to accommodate the Broeslow System of colour coded drawers
- Ensures doctors and technicians can quickly identify critical supplies in emergencies – when records matter
- Fitted standard with a keyless breakaway lock and comprehensive range of standard accessories
- Featuring all the benefits of the entire Aidacare range

\* Two drawer sizes available: 3" (7cm) and 6" (16cm)

### LOCK TYPE



Breakaway

**5 YEARS WARRANTY**  
Structural

**1 YEAR WARRANTY**  
Accessories

Code	Size	Height	Length	Width	Drawers
WAT909690	L	110cm / 10H	61cm	79cm	8x 3", 1x 6", 0x 9"

## Medication Sachet Cart



- The Aidacare Medication Sachet Cart offers large capacity and flexible organisation of treatment supplies in 3" and 9" seamless drawers that feature a unique integrated divider system
- Includes an expansive work area, with a slide out work surface if more space is needed
- The durable steel frame and unique spread caster position ensure stability, making the cart easy to move and control
- Choose from an array of accessories options to optimise the cart for your facility's treatment needs

\* Three drawer sizes available: 3" (7cm), 6" (16cm) and 9" (25cm)

### LOCK TYPE

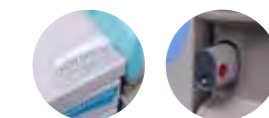

Digital Key

**5 YEARS WARRANTY**  
Structural

**5 YEARS WARRANTY**  
Digital Lock

**1 YEAR WARRANTY**  
Accessories

Code	Description	Size	Height	Length	Width	Drawers
WAT909520	Digital Lock - Cream	S	90cm / 8H	61cm	79cm	5x 3", 0x 6", 1x 9"
WAT909530	Digital Lock - Cream	M	100cm / 9H			6x 3", 0x 6", 1x 9"
WAT909440	Digital Lock - Blue	M	100cm / 9H			6x 3", 0x 6", 1x 9"
WAT909570	Key Lock - Cream	S	90cm / 8H			5x 3", 0x 6", 1x 9"
WAT909480	Key Lock - Blue	M	100cm / 9H			6x 3", 0x 6", 1x 9"
WAT909580	Key Lock - Cream	M	100cm / 9H			6x 3", 0x 6", 1x 9"

## Anaesthesia Carts



- The Aidacare Anaesthetic Cart is the flexible solution to your workflow needs
- Combined with its sleek lines, strong construction, and easy manoeuvrability, it offers a fully customisable solution to meet individual needs
- Packed with standard accessories, it allows for choice of cart height, draw depth, locking option and storage configuration to perfectly compliment your workflow needs

### LOCK TYPE

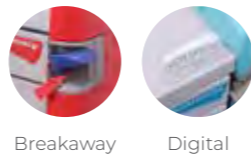

\* Three drawer sizes available:  
3" (7cm), 6" (16cm) and 9" (25cm)

Code	Description	Size	Height	Length	Width	Drawers
WAT909630	Digital Lock - Green	S	90cm / 8H	61cm	79cm	1x 3", 2x 6", 1x 9"
WAT909640	Digital Lock - Green	M	100cm / 9H			2x 3", 2x 6", 1x 9"
WAT909650	Digital Lock - Green	L	110cm / 10H			1x 3", 3x 6", 1x 9"
WAT909660	Breakaway - Green	S	90cm / 8H			1x 3", 2x 6", 1x 9"
WAT909670	Breakaway - Green	M	100cm / 9H			2x 3", 2x 6", 1x 9"
WAT909680	Breakaway - Green	L	110cm / 10H			1x 3", 3x 6", 1x 9"

**5 YEARS WARRANTY**  
Structural

**5 YEARS WARRANTY**  
Digital Lock

**1 YEAR WARRANTY**  
Accessories

## Isolation Cart



- The Aidacare Isolation Cart offers all the desirable features for high-risk infection control areas
- From its smooth, brightly coloured exterior, to its configurable large-volume deep drawers.
- Capable of supporting heavier loads with its strong robust construction, this will be your cart of choice
- Standard with waste bin, extended surface and dividers for all drawers, this value packed cart offers a comprehensive accessory list

\* Two drawer sizes available:  
6" (16cm) and 9" (25cm)

Code	Size	Height	Length	Width	Drawers
WAT909610	S	90cm / 8H	61cm	79cm	0x 3", 1x 6", 2x 9"
WAT909620	M	100cm / 9H			0x 3", 0x 6", 3x 9"

**5 YEARS WARRANTY**  
Structural

**1 YEAR WARRANTY**  
Accessories

## Aidacare Cart Accessories



- Oxygen Tank Holder
- Waste Bin with Lid
- Plastic Seal Lock
- Small Tilt Bin Unit
- Medium Tilt Bin Unit
- Large Tilt Bin Unit
- CPR Board
- Adjustable IV Pole
- Sharps Container Holder
- Glove Box Container
- Drawer Dividers
- Drawer Sub-Dividers
- Accessory Rail
- Defibrillator Shelf
- Accessory Tower
- Tablet Holder
- Laptop Holder
- Castors
- Drawer Tab Fillers
- Drawer Label Plastic Tag
- Top Surface Clear Mat
- Labels

**1 YEAR WARRANTY**  
Accessories

\*Sharps container not included

	Code	Product
1	WAT907100	Oxygen Tank Holder
2	WAT907136	Waste Bin with Lid
3	WAT907690	Plastic Seal Lock
4	WAT907155	Small Tilt Bin Unit - 6 Compartment
5	WAT907150	Medium Tilt Bin Unit - 5 Compartment
6	WAT907140	Large Tilt Bin Unit - 4 Compartment
7	WAT907120	CPR Board
8	WAT907130	Adjustable IV Pole
9	WAT907135	Sharps Container Holder*
10	WAT907134	Glove Box Container
11	WAT907330	Drawer Dividers - Short - Grey
	WAT907335	Drawer Dividers - Tall - Grey
12	WAT907350	Drawer Sub-Dividers All Drawers - Clear - 3"
	WAT907340	Drawer Sub-Dividers All Drawers - Clear - 7"
	WAT907341	Drawer Sub-Dividers for 6" & 9" Drawers, Clear 7" Tall
	WAT907355	Drawer Sub-Dividers for 6" & 9" Drawers, Clear 5" Tall
13	WAT907352	Drawer Sub-Dividers for Narrow Drawers, Clear 5"
13	WAT907133	Accessory Rail

	Code	Product
14	WAT907110	Defibrillator Shelf
15	WAT907190	Accessory Tower
16	WAT907205	Tablet Holder
17	WAT907202	Laptop Holder
18	WAT907661	150mm Non-Braking Castor
	WAT907662	150mm Braking Castor
	WAT907663	150mm Tracking Castor
19	WAT907325	Drawer Tab Fillers - Grey
	WAT907326	Drawer Tab Fillers - Blue
	WAT907327	Drawer Tab Fillers - Yellow
	WAT907328	Drawer Tab Fillers - Green
20	WAT907329	Drawer Tab Fillers - Red
	WAT907105	Drawer Label - Plastic Tag
	WAT907131	Top Surface Clear Mat
22	WAT907400	Red Label - Emergency Cart
	WAT907380	Green Label - Anaesthesia Cart
	WAT907410	Yellow Label - Isolation Cart
	WAT907420	Blue Label - Medication Cart

ARTG - 203303 - Accessory Rail and Sharps Container Holder



## eCart Range

- Lightweight composite aluminium/plastic panels, reduces cart noise while in motion and damaged panels can be easily replaced
- Drawers fitted with soft close runners and dampeners - prevents drawers from opening while in motion
- Height adjustable push handles
- Raised drawer handles for grip and easy cleaning
- Recessed ABS plastic top and storage compartment
- Slide out shelf fitted with runners for smooth, stable operation
- Keyed mechanical lock or optional digital lock
- 3x 125mm anti-static total lock castors, 1x directional lock castor

**5 YEARS WARRANTY**  
Frame

**2 YEAR WARRANTY**  
Electronics

ARTG - 281758

B. **Economy Cart - 3 Drawers**  
Fixed Push Handle & Dividers (12)



C. **Medication Cart - 3 Drawers**  
(Webster)



D. **Medication Cart - 4 Drawers**  
Dividers (12)



E. **Medication Cart - 5 Drawers**  
Dividers (12)



F. **Med/Theatre Wide Cart**  
4 Drawers, Dividers (12 & 14)



G. **Med/Theatre Wide Cart**  
5 Drawers, Dividers (12 & 14)



A. **Economy Cart - 2 Drawers**  
Fixed Push Handle (Webster)



H. **Anaesthetic Cart - 5 Drawers**  
Blue, Stainless Steel Top, Guardrail,  
Tilt Containers (17)



I. **Emergency Cart - 5 Drawers**  
Red, Oxy carrier, IV Pole, Cardio Board



J. **Sachet Cart - 6 Drawers**  
Dividers (10)



K. **Procedure Cart - 5 Drawers**  
Grey, IV Pole, Storage Basket



L. **Isolation Cart - 4 Drawers**  
Yellow, Glove Dispenser Holder,  
Dividers (12)



## eCart Range Specification

	Code	Description	Overall Length	Overall Width	Overall Height
	A	WAT901100 Economy Cart - 2 Drawer + Fixed Push Handle (Webster)	520mm	760mm	1075mm
	B	WAT901110 Economy Cart - 3 Drawer + Dividers (12) + Fixed Push Handle	520mm	760mm	1075mm
	C	WAT901120 Medication Cart - 3 Drawer (Webster)	520mm	760mm	1045mm
	D	WAT901130 Medication Cart - 4 Drawer + Dividers (12)	520mm	760mm	1045mm
	E	WAT901140 Medication Cart - 5 Drawer + Dividers (12)	520mm	760mm	1045mm
	F	WAT901150 Medication/Theatre Wide Cart - 4 Drawer + Dividers (12 & 14)	570mm	870mm	1065mm
	G	WAT901160 Medication/Theatre Wide Cart - 5 Drawer + Dividers (12 & 14)	570mm	870mm	1065mm
	H	WAT901170 Anaesthetic Cart (Blue) - 5 Drawer + S/Steel Top + Guardrail + Tilt Containers (17)	545mm	760mm	1580mm
	I	WAT901180 Emergency Cart (Red) - 5 Drawer + Oxy Carrier + IV Pole + Cardio Board	520mm	760mm	1075mm
	J	WAT901210 Sachet Cart - 6 Drawer + Dividers (10)	520mm	760mm	1045mm
	K	WAT901220 Procedure Cart (Grey) - 5 Drawer + IV Pole + Storage Basket	520mm	760mm	1045mm
	L	WAT901230 Isolation Cart (Yellow) - 4 Drawer + Glove Dispenser Holder + Dividers (12)	520mm	760mm	1045mm



eCart Accessories

1. Basket



2. Bottle Cabinet



3. Cardiac Board



4. Chart Holder



17. Waste Bin



18. Webster Clips (Pair)



19. Glove Dispenser



20. Corner Bracket for IV Pole



5. Dividers



6. Equipment Shelf - Double



7. Equipment Shelf - Single

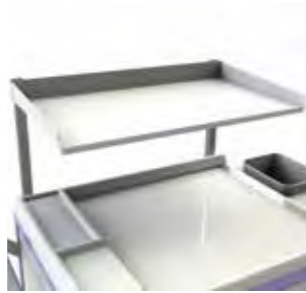

8. Guard Rail

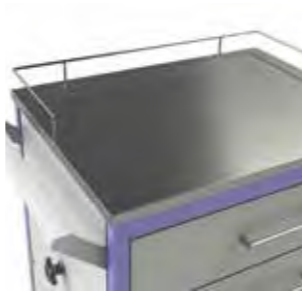

21 Anti-Tamper Lock



9. IV Pole with Corner Bracket



10. Oxygen Bottle Carrier



11. Sharps Holder



12. Stainless Steel Top



13. Tablet Arm



14. Tilt Container - 4



15. Tilt Container - 5



16. Tilt Container - 6



	Code	Product
1	WAT902110	Basket
2	WAT902120	Bottle Cabinet - Fitted with Key Lock
3	WAT902130	Cardiac Board
4	WAT902140	Chart Holder
5	WAT902150	Dividers (1x Set) (4x3 = 12)
-	WAT902160	Divider Name Tabs
-	WAT902170	Defibrillator Arm
6	WAT902220	Equipment Shelf - Double
7	WAT902230	Equipment Shelf - Single
-	WAT902240	Folding Side Shelf
8	WAT902250	Guard Rail
9	WAT902260	Intravenous Pole with Corner Bracket
10	WAT902280	Oxygen Bottle Carrier
11	WAT902300	Sharps Holder

	Code	Product
12	WAT902310	Stainless Steel Top
13	WAT902320	Tablet Arm
14	WAT902330	Tilt Container - 4
15	WAT902340	Tilt Container - 5
16	WAT902350	Tilt Container - 6
-	WAT902360	Tilt Container - 9
-	WAT902370	Mount Arms for Tilt Container (Pair)
17	WAT902380	Waste Bin
18	WAT902390	Webster Clips (Pair) to Suit Wire Webster Rack
19	WAT902400	Glove Dispenser
20	WAT902261	Corner Bracket for Universal IV Pole
21	WAT902105	Anti-Tamper Lock
-	WAT901115	Drive Unit
-	WAT902090	Accessory Rail

### Linen Skip - No Lid



Single

- Stainless steel frame
- Open top (no lid)
- Fully welded joints assists with infection control
- Heavy duty 100mm swivel castors for safe manual handling
- Fixed uprights for swift bag removal



Double



Triple

5 YEARS WARRANTY

**OPTIONAL**

- Soiled Linen Skip Push Handle - Single - Stainless Steel (LAC500925)
- Soiled Linen Skip Bag Support - Stainless Steel (LAC500920)
- Buffer Disc and Reducing Bush to Suit Linen Skips (LAC500930)

Code	LAC500800	LAC500810	LAC500820
Size	Single	Double	Triple
Length	430mm	430mm	430mm
Width	430mm	860mm	1280mm
Height	940mm	940mm	940mm

### Linen Skip - Foot Operated Lid



Single

- Stainless steel frame
- Foot operated lid operation
- Fully welded joints assists with infection control
- Heavy duty 100mm swivel castors for safe manual handling
- Fixed uprights for swift bag removal
- Coloured lid labels included



Double



Triple

5 YEARS WARRANTY

**OPTIONAL**

- Soiled Linen Skip Push Handle - Single - Stainless Steel (LAC500925)
- Lid for Linen Skip White - With stickers (LAC500636)
- Soiled Linen Skip Bag Support - Stainless Steel (LAC500920)

Code	LAC500860	LAC500870	LAC500880
Size	Single	Double	Triple
Length	430mm	430mm	430mm
Width	460mm	920mm	1360mm
Height	945mm	945mm	945mm

### Economy Linen Skip - Foot Operated Lid



Single

- Powder coated steel frame
- Foot operated lid operation
- Fully welded joints assists with infection control
- 75mm swivel castors for safe manual handling
- Fixed uprights for swift bag removal
- Coloured lid labels included



Double



Triple

5 YEARS WARRANTY

**OPTIONAL**

- Lid for Linen Skip White - With stickers (LAC500636)
- Buffer Disc and Reducing Bush to Suit Linen Skips (LAC500930)

Code	LAC500890	LAC500900	LAC500910
Size	Single	Double	Triple
Length	430mm	430mm	430mm
Width	430mm	860mm	1280mm
Height	940mm	940mm	940mm

### Soiled Linen Bags



- Replacement soiled linen bags to suit linen skips
- Available in full size, half size, and waterproof variations

**COLOUR OPTIONS**



Code	Type	Colour	Capacity
LAC353130	Standard	White	15kg
LAC353140	Standard	Blue	15kg
LAC353160	Standard	Green	15kg
LAC353170	Standard	Red	15kg
LAC353180	Standard	Yellow	15kg
LAC353190	Standard	Purple	15kg
LAC353060	Waterproof	White	15kg
LAC353020	Waterproof	Blue	15kg
LAC353040	Waterproof	Green	15kg

Code	Type	Colour	Capacity
LAC353050	Waterproof	Red	15kg
LAC353070	Waterproof	Yellow	15kg
LAC353030	Waterproof	Black	15kg
LAC353105	Half Size (OH&S)	White	10kg
LAC353106	Half Size (OH&S)	Blue	10kg
LAC353107	Half Size (OH&S)	Green	10kg
LAC353108	Half Size (OH&S)	Red	10kg
LAC353109	Half Size (OH&S)	Yellow	10kg
LAC353110	Half Size (OH&S)	Purple	10kg

1 YEAR WARRANTY

### Economy Linen Skip - No Lid



Single

- Powder coated steel frame
- Open top (no lid)
- Fully welded joints assists with infection control
- 75mm swivel castors for safe manual handling
- Fixed uprights for swift bag removal



Double



Triple

5 YEARS WARRANTY

**OPTIONAL**

- Soiled Linen Skip Bag Support - Stainless Steel (LAC500920)

Code	LAC500830	LAC500840	LAC500850
Size	Single	Double	Triple
Length	430mm	430mm	430mm
Width	430mm	860mm	1290mm
Height	890mm	890mm	890mm

### Soiled Linen Trolley Lids



- Replacement lid for foot operated linen trolley
- Lids available in a variety of colours

**COLOUR OPTIONS**



Code	Type	Colour
LAC500636	Plastic with Stickers	White
LAC354100	Plastic	Blue
LAC354110	Plastic	Green
LAC354130	Plastic	Red
LAC354150	Plastic	Yellow

1 YEAR WARRANTY



## Moist Linen Trolley



- Mobile trolley designed to transport and dispose soiled linen in hospital environments
- Strong galvanised base
- Durable polyethylene linen tub
- 4x heavy duty 125mm swivel castors for safe manual handling



125mm Swivel Castors

### OPTIONAL

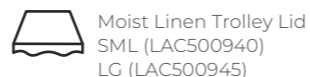

<b>Code</b>	LAC354025	LAC354030
<b>Size</b>	Small	Large
<b>Length</b>	1000mm	1360mm
<b>Width</b>	710mm	750mm
<b>Height</b>	790mm	790mm
<b>Capacity</b>	320L	450L

**3 YEARS WARRANTY**

## Wet & Dry Linen Trolley



- Lightweight yet robust mesh design with powder coated steel frame
- Spring assisted adjustable base with spring covers reduce linen entrapment
- Small has 4x HD 125mm rubber swivel castors
- Medium has 2x HD 150mm rubber fixed castors + 2x HD 150mm rubber swivel castors
- Large has 4x HD 200mm rubber swivel castors
- Self lubricating anti rattle platform guides
- 4x corner rotating wall buffers

<b>Code</b>	LAC353380	LAC354190	LAC354210
<b>Size</b>	Small	Medium	Large
<b>Length</b>	800mm	1100mm	1400mm
<b>Width</b>	600mm	680mm	800mm
<b>Height</b>	800mm	850mm	850mm

**3 YEARS WARRANTY**

## Economy Clean Linen Trolley



Large - open (3 Shelf)



Small - closed (2 shelf)

- Durable lightweight design
- Raised top tray edging prevents spillage
- Powder coated steel frame
- 4x corner buffers prevent wall damage
- Multi height push handle (large only)
- Directional castor (large model only)

### OPTIONAL

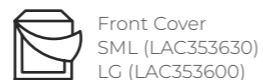

<b>Code</b>	LAC353640	LAC353610	LAC353620	LAC353590
<b>Size</b>	Small - Open	Large - Open	Small - Closed	Large - Closed
<b>Length</b>	920mm	1100mm	920mm	1100mm
<b>Width</b>	525mm	550mm	525mm	550mm
<b>Height</b>	1040mm	1400mm	1040mm	1400mm

**3 YEARS WARRANTY**

## Deluxe Clean Linen Trolley



- Durable lightweight design
- Stainless steel tow hitch connection
- Raised top tray edging prevents spillages
- Two tone powder coated steel frame
- 4x corner buffers prevents damage to walls
- Multi height push handle
- 2x directional castors

### OPTIONAL

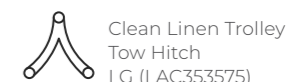

<b>Code</b>	LAC353560
<b>Length</b>	1285mm
<b>Width</b>	625mm
<b>Height</b>	1430mm

**3 YEARS WARRANTY**

## Linen Folding Table



- 4x heavy duty 125mm swivel castors
- Durable robust construction
- Powder coated steel frame
- Promotes quick and efficient linen storage time



Raised PVC Work Surface



125mm Swivel Castors

<b>Code</b>	LAC501000	LAC501010
<b>Operation</b>	Fixed Height	Electric
<b>Length</b>	1200mm	1200mm
<b>Width</b>	650mm	650mm
<b>Height</b>	900mm	900mm

**3 YEARS WARRANTY**

## Garment Dispensing Trolley



15 Trays

- Durable lightweight design
- Powder coated steel frame
- 4x corner buffers prevents damage to walls
- Push handle on both ends
- Name tags to identify patient belongings



Push Handles

<b>Code</b>	LAC353650	LAC353660	LAC353680	LAC353470
<b>Capacity</b>	15 Trays	18 Trays	30 Trays	Tray
<b>Length</b>	1100mm	1100mm	1450mm	430mm
<b>Width</b>	490mm	490mm	700mm	325mm
<b>Height</b>	1300mm	1500mm	1375mm	130mm

**5 YEARS WARRANTY**



### Garment Rack



- Epoxy Powder coated frame
- Flat pack base and upright design
- Nestable 'Z' Base design

5 YEARS WARRANTY

Code	LAC353462
Type	Z Base
Length	1425mm
Width	650mm
Height	1750mm

### Food Tray Clearing Trolley



- Lightweight stainless steel, fully welded construction
- 40mm safe edge on top of tray to prevent spills
- Push handle at both ends
- Stainless steel frame
- 4x 125mm grey rubber swivel castors



125mm Swivel Castors

5 YEARS WARRANTY

Code	WAT824400	WAT824600
Size	2 Shelf	3 Shelf
Length	800mm	800mm
Width	500mm	500mm
Height	950mm	950mm

### Stock Trolley



- Lightweight robust construction with fixed perforated basket
- Push Handle on both ends
- Heavy duty 125mm polyurethane swivel castors with swivel buffer discs for wall protection
- Epoxy powder coated finish



125mm Swivel Castors

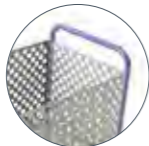

Push Handle

5 YEARS WARRANTY

Code	WAT825510
Length	700mm
Width	450mm
Height	950mm

### File Trolley



- 25mm push handle at both ends
- Lightweight
- Swivel wall buffers
- Storage Tray
- 100mm swivel castors



Accepts standard suspension files



Push Handle

5 YEARS WARRANTY

OPTIONAL



File Trolley Lid - Lockable (WAT900920)

Code	WAT900910
Size	File Trolley
Length	950mm
Width	420mm
Height	980mm

### Food Tray Dispensing Trolley



8 Tray Trolley

- Stainless steel top shelf
- Push handle at both ends
- Stainless steel frame
- 2x directional lock castors
- 2x directional swivel castors
- Corner buffers
- Can be manufactured to suit any tray size or configuration

OPTIONAL



Food Tray - 450 x 350mm - Plastic Small (WAT824700)



Cover for 8 Tray Trolley Pockets & 4 Grips (WAT824716)

Cover for 16 Tray Trolley Pockets & 4 Grips (WAT824717)

Cover for 24 Tray Trolley Pockets & 4 Grips (WAT824715)

Code	WAT823500	WAT823600	WAT824000
Capacity	8 Tray	16 Tray	24 Tray
Length	460mm	575mm	575mm
Width	615mm	900mm	1330mm
Height	1490mm	1490mm	1490mm

5 YEARS WARRANTY

### Flow Chart Trolley



- Lightweight aluminium work platform 670mm x 800mm
- Spring assisted high / low adjustment 850-1300mm, 3x flow chart clips
- Pen and implement retainer
- Stainless steel uprights
- Epoxy powder coated top
- Stable 4 point pre zinc treated epoxy powder coated contoured base
- 2x 100mm total lock grey rubber castors



100mm Swivel Castors

5 YEARS WARRANTY

Code	WAT900940
Width	800mm
Height	850-1300mm

## Arm Operating Table



- Robust stainless steel construction with no cross bars allowing access from both sides
- X-ray translucent top
- Height adjustable 670-825mm
- 100mm total lock grey rubber castors

**5 YEARS WARRANTY**

Code	WAT820190
Length	850mm
Width	450mm
Height	670-825mm

## Mobile Nesting IV Pole



- Nesting base design to minimise storage space
- Organised storage system
- One hand height adjustment
- Cast iron base with stainless steel pole for stability, durability and better performance with heavy devices

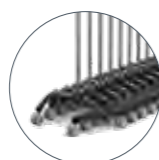

Nesting Base

**2 YEARS WARRANTY**

Code	WAT820185
Width	637 x 518mm
Height	1354 - 2214mm

ARTG - 303542

## Mobile Nesting PPE Dispenser

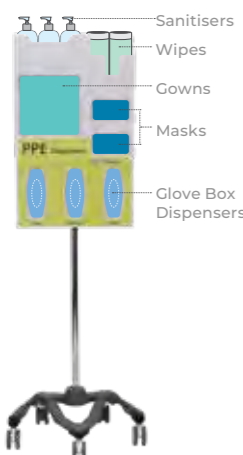

- Nesting base design to minimise storage space
- 5 Star polyurethane base
- Organised storage system
- One hand height adjustment
- Cast iron base with stainless steel pole for stability, durability and better performance with heavy devices

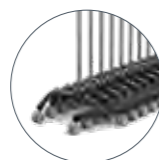

Nesting Base



Wall Mountable Option

### OPTIONAL



Wall Mountable (WAT824752)

**2 YEARS WARRANTY**

Code	WAT820187
Width	637 x 518mm
Height	1354 - 2214mm

ARTG - 303542

## Instrument / Dressing Trolley (Stainless Steel)

- Stainless steel construction
- Total lock castors on front wheels
- Guard rail on 3 sides
- Drawers fitted with high quality runners with soft close magnetic latch
- 140mm deep drawers



Instrument Trolley - Square Frame - WAT900800



Instrument Trolley - Square Frame + 1 Drawer - WAT900810



Instrument Trolley - Square Frame + 2 Drawers - WAT900820



Dressing Trolley - Square Frame + 2 Drawers - WAT900860



Instrument Trolley - Square Frame + 4 Drawers - WAT900830



Dressing Trolley - Square Frame WAT900840



Dressing Trolley - Square Frame + 1 Drawer - WAT900850



Dressing Trolley - Square Frame + 4 Drawers - WAT900870



Dressing Trolley - Square Frame + 2 Drawers side by side - WAT900861



Dressing Trolley - Large - 2 Drawers WAT900860

Trolley	Instrument	Dressing
Length	500mm	800mm
Width	500mm	500mm
Height	1040mm	1040mm

**5 YEARS WARRANTY**

## Instrument / Dressing Trolley - Flat Top



- Stainless steel construction
- Flat top fully welded
- 100mm total lock castors

**5 YEARS WARRANTY**

Code	WAT900880	WAT900890	WAT900900
Length	500mm	800mm	1000mm
Width	500mm		
Height	950mm		

## Instrument / Dressing Trolley - Square Frame



- Large instrument trolley with flat surfaces
- 304 stainless steel construction
- Tig weld manufacture
- 2x 100mm brake lock castors
- 2x 100mm swivel castors
- Electro-polished finish

**5 YEARS WARRANTY**

Code	WAT900800
Length	500mm
Width	500mm
Height	950mm

# Treatment Chairs

---

In hospitals and medical facilities, treatments are often easier and more convenient to administer while the patient is in a chair rather than a bed.

Treatment chairs are specially designed to allow for the quick and comfortable treatment of patients. They are especially ideal for day patients and are often used for oncology/IV treatment, pathology, and ambulatory care.

At Aidacare, we stock a variety of treatment chairs to suit various hospital and clinical needs.

Designed for optimal patient comfort, our medical treatment chairs are padded and adjustable. As such, they allow patients to sit, recline or lie down for extended periods of time while receiving care. Our treatment chairs are strong and durable. They are ideal for a range of weights and are easy to clean to ensure maximum hygiene.



# IDEA Clinic Treatment Chair



COLOUR OPTIONS

- Navy Blue Vinyl

OPTIONAL ACCESSORIES

- IV Pole
- Tray Pole



**BIOCOTE**  
Antibacterial frame coating for improved infection control



Code	CHT100700
Overall Length	910mm
Overall Width	730mm
Overall Height	480 - 780mm
Patient Surface Length	1720mm
Patient Surface Width	560mm
Backrest Angle	80°
Trendelenburg	6°
Castor Size	100mm
SWL	200kg

Features and Benefits

- Compact therapy couch that effortlessly meets the needs of oncology departments and the demands of infusion and transfusion medicine
- Gas-assisted height adjustable and swing-away armrests to suit individual user needs
- Ideal for procedures such as chemotherapy, dialysis, blood donation, and blood transfusion
- Flip down footrest to be used during portering or patient movement
- 3 motors allow multiple positioning options for maximum patient comfort
- Seamless patient surface for maximised infection control compliance
- Genuine chair position with leg section at 90° angle
- Intuitive handset allows for quick and easy chair repositioning
- Ergonomic push handle with inbuilt paper roll holder
- 100mm castors with directional tracking ability
- Inbuilt IV pole receiver, additional pole available as an accessory

ARTG: 288974

# IDEA2 Treatment Chair



COLOUR OPTIONS

- Navy Blue Vinyl

OPTIONAL ACCESSORIES

- IV Pole
- Tray Pole



**BIOCOTE**  
Antibacterial frame coating for improved infection control



Features and Benefits

- Premium therapy couch that effortlessly meets the needs of oncology departments and the demands of infusion and transfusion medicine
- Gas-assisted height adjustable and swing-away armrests to suit individual user needs
- Ideal for procedures such as chemotherapy, dialysis, blood donation, and blood transfusion
- Extra-long leg rest for patient comfort during extended periods of treatment
- Intuitive handset allows for quick and easy chair repositioning
- Ergonomic push handle with inbuilt paper roll holder
- 5 motors allow multiple positioning options for maximum patient comfort
- Seamless patient surface for maximised infection control compliance
- 100mm twin-wheel castors with directional tracking ability
- Inbuilt IV pole receiver, additional pole available as an accessory

ARTG: 288974

Code	CHT100710
Overall Length	1600mm
Overall Width	840mm
Overall Height	570 - 890mm
Patient Surface Length	2130mm
Patient Surface Width	580mm
Backrest Angle	80°
Trendelenburg	12°
Castor Size	125mm
SWL	200kg

# Examination Couches and Equipment

---

Examination couches, tables, and equipment, provide patients with a comfortable and safe surface to sit or lay on while being examined and treated by medical staff. The Aidacare range of exam tables and couches includes a variety of options to suit the different needs of hospitals and medical facilities.

Our selection features treatment tables, tilt tables, two- and three-section couches, electric hi lo couches, Bobath plinths and bariatric examination tables. Our examination beds are highly adjustable and configurable. As such, they allow medical professionals to easily examine and treat patients at the most ergonomic height.

All of our options are robust and durable with many also featuring lockable castors for mobility and safety. The medical examination couches also feature padding for patient comfort and support.

## 2 Section Adjustable Examination Couch



- Electric HiLo operation by foot switch
- Sleek design with rounded frame legs for safety
- Minimum to maximum height in 30 seconds
- Adjustable head section through dual gas operated struts from -20° to +80°
- Retractable dual locking castors on all four castors
- Head section has face hole and plug
- Adjustable feet for uneven surfaces
- 75mm castors for safety and mobility

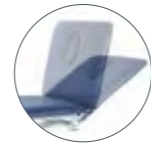

Adjustable Head Section

<b>Code</b>	WAT821550
<b>Overall Length</b>	1950mm
<b>Overall Width</b>	710mm
<b>Overall Height</b>	480 - 900mm
<b>SWL</b>	250kg

SWL 250kg

INFECTION CONTROL

BARIATRIC

5 YEARS WARRANTY Frame

3 YEAR WARRANTY Electrics

ARTG - 279095

## 5 Section Examination Couch - Electric Hi/Lo



- Electric HiLo operation by foot switch
- Sleek design with rounded frame legs for safety
- Minimum height 550mm to maximum height 900mm in 30 seconds
- Dual motor
  1. Electric HiLo
  2. Postural drainage
- Adjustable head section featuring single gas strut, angle adjustable from -20° to +45°
- Adjustable leg section featuring double gas struts, angle adjustable from +0° to +80°
- Retractable dual locking 75mm castors on all four corners
- Head section has face hole and plug, and adjustable feet for uneven surfaces



Adjustable Head Section

<b>Code</b>	WAT821565
<b>Overall Length</b>	1860mm
<b>Overall Width</b>	600mm
<b>Overall Height</b>	550 - 950mm
<b>SWL</b>	250kg

SWL 250kg

INFECTION CONTROL

BARIATRIC

5 YEARS WARRANTY Frame

3 YEAR WARRANTY Electrics

ARTG - 279095

## 3 Section Examination Couch - Electric Hi/Lo



- Electric HiLo operation by foot switch
- Sleek design with rounded frame legs for safety
- Minimum to maximum height in 30 secs
- Adjustable head section, angle adjustable from -45° to +70° and -90° to +40° (Short Head model)
- Adjustable leg section featuring double gas struts, angle adjustable from -45° to +70° and +0° to +90° (Short Head model)
- Head section has face hole and plug, adjustable feet for uneven surfaces
- Retractable dual locking 75mm castors on all for corners



Adjustable Head Section

<b>Code</b>	WAT821555	WAT821560 (W/ Short Head)
<b>Overall Length</b>	1900mm	1950mm
<b>Overall Width</b>	710mm	660mm
<b>Overall Height</b>	500 - 900mm	480 - 900mm
<b>SWL</b>	250kg	250kg

SWL 250kg

INFECTION CONTROL

BARIATRIC

5 YEARS WARRANTY Frame

3 YEAR WARRANTY Electrics

ARTG - 279095

## 2 Section Fixed Examination Couch



- Fixed height 82cm
- New easy lift and lock mechanism for easy assembly
- Lift up back section for assessment
- Comes flat packed to save on freight
- Padding thickness 5cm
- Foam density: 36g/m2
- Breathe hole available on request

<b>Code</b>	WAT821575
<b>Overall Length</b>	1950mm
<b>Overall Width</b>	710mm
<b>Overall Height</b>	820mm
<b>SWL</b>	250kg

SWL 280kg

INFECTION CONTROL

1 YEAR WARRANTY

ARTG - 279095



## Medical Stool



- Adjustable height: 490mm - 630mm
- Cushion diameter: 350mm
- Foam thickness: 60mm
- Foot pedal for best hygiene practice



Adjustable Height Foot Pedal

**2 YEARS WARRANTY**

<b>Code</b>	WAT803850
<b>Overall Height</b>	560 - 750mm

## Anaesthetic Stool



- Adjustable height: 490mm - 630mm
- Cushion diameter: 350mm
- Foam thickness: 60mm
- \*Premium version has additional foot ring

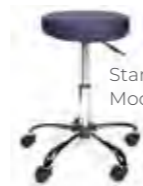

Standard Model

**3 YEARS WARRANTY**

<b>Code</b>	WAT803200 - Navy	WAT803100 - Navy w/ Foot Ring
<b>Overall Height</b>	490 - 630mm	490 - 630mm

## Saddle Stool



- Adjustable height: 490mm - 630mm
- Cushion diameter: 350mm
- Foam thickness: 60mm

**3 YEARS WARRANTY**

<b>Code</b>	WAT803500 (Navy)	WAT803600 (Black)
<b>Overall Height</b>	490 - 630mm	490 - 630mm

## Post Operative Step



- Adjustable height: 490mm - 630mm
- Cushion diameter: 350mm
- Foam thickness: 60mm

**1 YEAR WARRANTY**

<b>Code</b>	BEA014900 (Single)	BEA014800 (Double)
<b>Overall Height</b>	240mm	220mm & 400mm

## Weigh Chair Digital



- Ideal for accurate and convenient patient weighing
- Easy to read weight display
- Swivel wheels with safety brakes plus built in footrests
- Easy to clean surfaces essential in health care environments
- 100 hours use from regular batteries

**SWL 150kg**

**1 YEAR WARRANTY**

<b>Code</b>	LSS377700
<b>Overall Length</b>	635mm
<b>Overall Width</b>	680mm
<b>Overall Height</b>	880mm
<b>SWL</b>	150kg

## Healthweigh Chair Scale



- The Healthweigh Chair Scale allows for carers to measure the weight of residents in a safe and comfortable manner. The ergonomically contoured seat and folding armrests ensure patient comfort and ease of transfers whilst the large LCD screen provides accurate weight measurements for carers.
- Movement compensation technology
- BMI function
- Fold back armrests
- Rear locking castors
- Automatic Reweigh
- Ergonomic contoured seating surface
- Auto power off
- Rechargeable battery

**SWL 300kg**

**2 YEARS WARRANTY**

<b>Code</b>	LSS377706
<b>Overall Length</b>	850mm
<b>Overall Width</b>	630mm
<b>Overall Height</b>	965mm
<b>Seat Width</b>	430mm
<b>Seat Depth</b>	420mm
<b>Unit Weight</b>	18kg
<b>SWL</b>	300kg

## Folding Screen - 3 Bay



- Robust hinge
- Easy clean curtain material
- Stainless steel frames
- Heavy duty 75mm rubber swivel castors



Screen Folded Position

**5 YEARS WARRANTY**

<b>Code</b>	WAT825250
<b>Overall Length</b>	1930mm
<b>Overall Width</b>	470mm
<b>Overall Height</b>	1930mm
<b>Folded Length</b>	730mm
<b>Folded Width</b>	470mm
<b>Folded Height</b>	1930mm

# Workstations on Wheels

---

Aidacare offers two modern, state of the art ranges of Work Station on Wheels from NuboMed.

The X-Series medical carts are lightweight, agile, and flexible mobile nursing care with modular design, on-demand modification for clinic. The S Series embodies a clean and simple design for smart working in patient care settings.

The NuboMed product range integrates and works together to provide intelligent closed loop management for medication and materials for full process traceability from supplier to patient. The hardware collects real-time data while the software standardises clinical processes and the data platform integrates and analyses the information.

Closing the medication loop increases efficiency and reduces costs and provides reliable data for accountability and decision making - improving processes and leaving more time for quality patient care.

# Medical Carts X Series

Lightweight, agile, and flexible mobile nursing care with modular design and on-demand modification for clinics.

NuboMed intelligent mobile workstation adheres to the clean, simple, and smart design concepts. Lightweight fuselage integrated with embedded computer, wireless communication modules, intelligent batteries, power supply, and IoT technology.

Tailor made specifically for clinical ward rounds, nursing, monitoring, bedside treatment, medicine dispensary, and billing functionality. Returns medical staff back to their basics. Combines technology with medical treatment while providing optimal patient care.

## X1000 Medical Treatment Cart

NuboMed



- Ergonomic double handles, easy to manoeuvre from all angles.
- New aviation grade alloy material, lightweight yet tough
- Spacious work surface, nano-particle technology, smooth yet not slippery, dirt proof
- A variety of accessories and drawer combinations
- Mechanical lock for security

**Ideal For:**  
Emergency Nursing/Treatment

2 YEARS WARRANTY

Code	Product
WAT908190	NuboMed X1000

## X2000 Lite Medical Cart

NuboMed



- For doctor and nursing rounds
- A variety of accessories and drawer combinations
- Mechanical lock for security
- Hot-swappable main and auxiliary batteries, 24h uninterrupted usage
- Imported Panasonic battery core from Japan, safety guaranteed
- Wireless charging (Phone/PDA), RFID user log-in

**Ideal For:**  
Doctor's Round/Training/Conferencing, Daily Nursing

2 YEARS WARRANTY

Code	Product
WAT908185	NuboMed X2000

## X3000 Lite Mobile Nursing Cart

NuboMed



- Front facing drawers for conventional operation
- A variety of accessories and drawer combinations
- Mechanical lock for security
- Embedded computer, HD display, design with care
- Hot-swappable main and auxiliary batteries, 24h uninterrupted usage
- Imported Panasonic battery core from Japan, safety guaranteed
- Wireless charging (Phone/PDA), RFID user log-in

**Ideal For:**  
Daily Nursing/Data Recording

2 YEARS WARRANTY

Code	Product
WAT908180	NuboMed X3000

## X4000 Advanced Mobile Nursing Cart

NuboMed



- Right side facing drawers, duo handles for side operations to maximise storage offerings
- Hidden and expandable work surface for maximum usage space
- A variety of accessories and drawer combinations
- Mechanical lock for security
- Embedded computer, HD display, design with care
- Hot-swappable main and auxiliary batteries, 24h uninterrupted usage
- Imported Panasonic battery core from Japan, safety guaranteed
- Wireless charging (Phone/PDA), RFID user log-in

**Ideal For:**  
Daily Nursing/Data Recording

2 YEARS WARRANTY

Code	Product
WAT908175	NuboMed X4000

## X5000 Medication Dispensing Cart

NuboMed



- Universal intelligent storage units across multiple platforms, UDD single dose units for fast loading and unloading, intelligent lock, user/drug recognition, ensuring closed-loop medication management
- Hidden and expandable work surface for maximum usage space and a variety of accessories and drawer combinations
- Mechanical lock for security
- Embedded computer, HD display, design with care
- Hot-swappable main and auxiliary batteries, 24h uninterrupted usage
- Imported Panasonic battery core from Japan, safety guaranteed
- Wireless charging (Phone/PDA), RFID user log-in

**Ideal For:**  
Closed Loop Intelligent Medication Management

2 YEARS WARRANTY

Code	Product
WAT908170	NuboMed X5000



# Medical Carts S Series

Clean and simple design for smart working in patient care settings.

The compact cart design of the S-Series provides a practical work space at the bedside. The retractable work surface further expands available area and the keyboard drawer extends to the same height as work space, continuing the integrated and streamlined surface. With smooth edges, the sleek all aluminium alloy carts are light weight and durable. Their compact base design is easy to navigate and operate at the bedside and offer electronic or manual height adjustment. The hot swappable battery pack offers 24 hours uninterrupted power with a power management system and quick charging technology. Standardised accessories and various drawer combinations allows for flexible and interchangeable options.

## S1000 Height Adjustable Laptop Cart



- Non-powered
- Tablet or laptop mount
- Suitable for patient rounds
- Lightweight and compact
- Height adjustable
- Optional accessories

2 YEARS WARRANTY

Code	Product
WAT908005	Nubomed S1000

## S3000 Height Adjustable Computer Cart



- Integrated PC (included)
- Suitable for longer bedside rounds and training
- Manual height adjustment (S3000L Only)
- Duo Battery (S3000H Only)

OPTIONAL

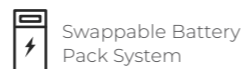

2 YEARS WARRANTY

Code	Product
WAT908120	Nubomed S3000
WAT908110	Nubomed S3000L
WAT908130	Nubomed S3000H

## S3020 Height Adjustable Computer Cart



- Integrated PC (included)
- Custom storage unit and accessories
- Suitable for longer bedside rounds, training, and nursing
- Manual height adjustment (S3020L Only)
- Duo Battery (S3020H Only)

OPTIONAL

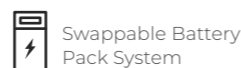

2 YEARS WARRANTY

Code	Product
WAT908150	Nubomed S3020
WAT908140	Nubomed S3020L
WAT908160	Nubomed S3020H

# Cart Accessories



1. Expandable Work Surface



2. Hidden Keyboard



3. Weighted Base



4. Pneumatic Lift Handle



<b>Dimension</b>	Length*Depth*Height: 765 x 576 x 1563mm (Height of work surface at the lowest point: 840mm, highest point: 1260mm)
<b>Unibody Construction</b>	One-piece unibody design with build in cart handle and minimum loose parts. Metal alloy and ABS material construction
<b>Work Surface</b>	One-piece work surface with maximum usage area: 430 x 460mm
<b>Hidden Tray</b>	Hidden keyboard tray and expandable work surface for additional usage area or act as mouse tray
<b>Height Adjustment</b>	Ergonomics design with pneumatic height adjustment to fit the height of each staff
<b>Cart Base</b>	Ergonomic design with build in weight to counter the risk of tipping over Space reserved to avoid tripping 4 noise proof casters with 2 lockable front ones Dimension: W440 x L480mm
<b>Cabinet</b>	Cabinet with optional 1 to 3 drawers selectable Small: W300 x D300 x H100mm / Large: W300 x D300 x H200mm
<b>Med Module</b>	Lockable drug bin module with 6 bins (Optional) Drug Bin Dimension: W93 x D175 x H75mm Med Module External Dimension: W270 x D480 x H350mm
<b>Accessories</b>	Various accessories for expansion: Sharp object container holder, waste basket, disinfectant holder, storage bins, left hand mouse tray, surface protection pad.

# Electronic Medication Management

---

Offering some of the world's leading technology, the NuboMed range of cabinets is unique in that in addition to our contracted cabinets, there is a suite of products, including carts, that will enable hospitals to scale up over time and finally achieve closed loop medication administration.

Our drug safes, by CMI Safe Company, are some of Australia's leading safes and boast high quality and local design.

The NuboMed product range integrates and works together to provide intelligent closed loop management for medication and materials for full process traceability from supplier to patient. The hardware collects real-time data while the software standardises clinical processes and the data platform integrates and analyses the information.

Closing the medication loop increases efficiency and reduces costs and provides reliable data for accountability and decision making - improving processes and leaving more time for quality patient care.

# M2300 Medication Cabinet

NuboMed



**OPTIONAL**



**APPLICATION**

Outpatient Pharmacy, Emergency Room, Pharmacy, Central Pharmacy and Clinical Ward

**MEDICAL TYPES**

Anaesthetic, High-Risk, High-Value, Toxic, Blister Packs, Boxed Drugs, Ampoules and Vials

**DRAWER CONFIGURATIONS**

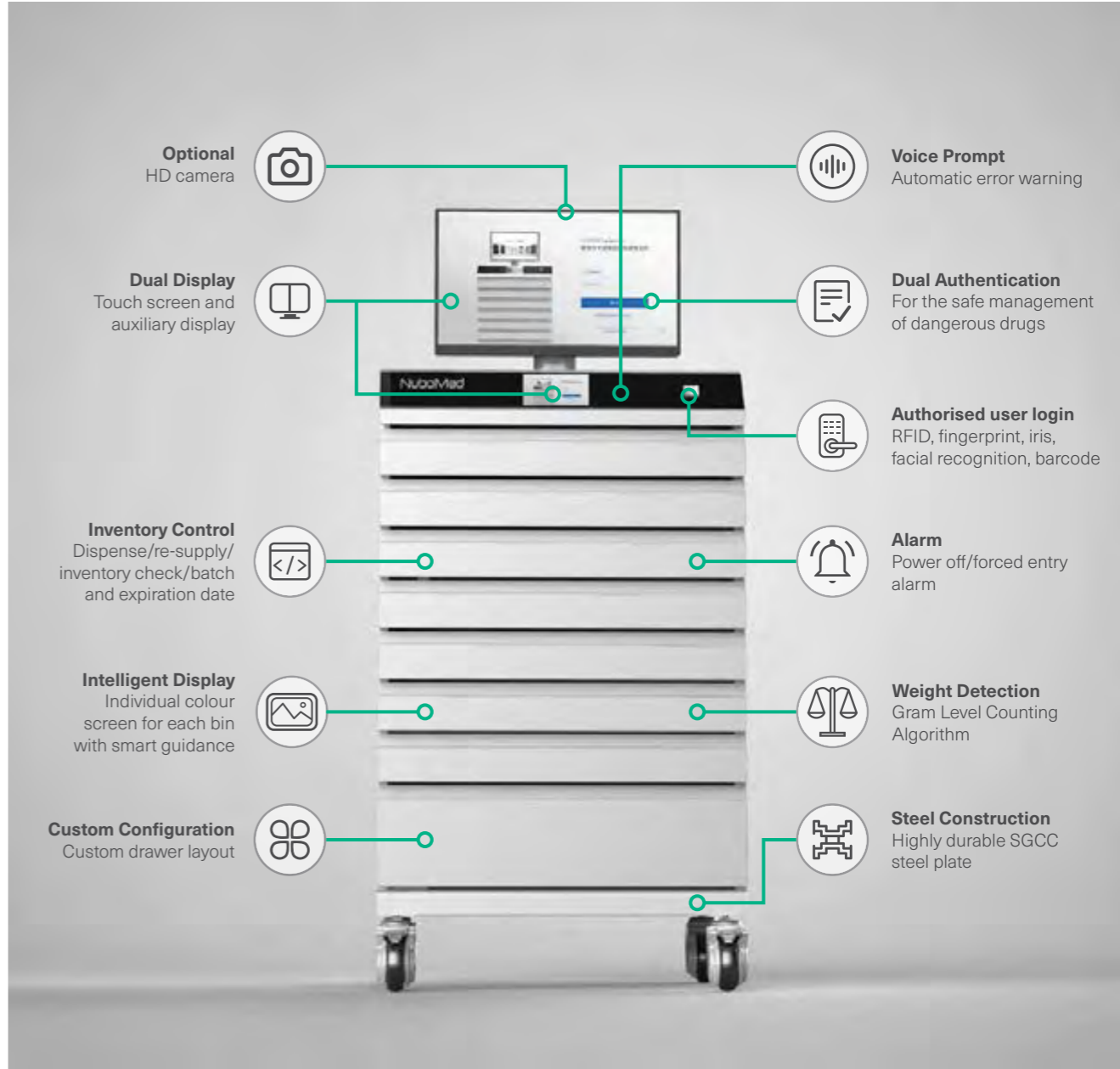
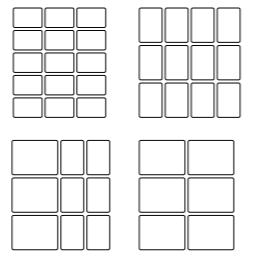

**Features and Benefits**

- Suitable for dispersed satellite inpatient area medication management and includes a central control system with eight drawers and 90 automatic counting enclosures
- Controlled drug autocounting enclosure (double verification): 1 drawer with 12 enclosures
- Ampoule autocounting enclosures: 6 drawers total 72 enclosures
- Voice prompt - automatic error warning
- High-strength aluminium alloy and metal with anodised surface
- Intelligent alarm - power off / forced entry alarm
- Intelligent lock control - authorised user login with multilevel control
- Intelligent monitoring - intelligent real-time quantity, expiration dates, and specification monitoring
- Intelligent display - individual colour screen for each bin with smart guidance
- Four directional castors

<b>Code</b>	WAT908500
<b>Description</b>	Intelligent Medication Cabinet (Ampoule) M2300
<b>Width</b>	700mm
<b>Depth</b>	695mm
<b>Height</b>	1539mm
<b>Power Interface</b>	AC, 100-240VAC, 320W
<b>Network Port</b>	Wired ethernet port
<b>UPS</b>	Back up UPS, 1000VA



Fingerprint recognition



Custom configuration



Multilevel control





## A2310 Medication Auxiliary Cabinet Nubomed



### INTELLIGENT MEDICATION CABINET (PACKED MED) TYPE A

Suitable for dispersed satellite inpatient area medication management. Includes seven levels, 28 automatic counting enclosures with LED display and glass door.

- High-strength aluminium alloy and metal with anodised surface
- Intelligent lock control - authorised user set up for cabinet lock access, allows individual set up for each bin
- Layers - 7 layers, 4 medicine bins per layer
- Door type - 1 transparent tempered safety glass door
- Speaker - voice prompt
- Intelligent real-time quantity and specification monitoring
- Intelligent display - each bin is equipped with a colour LED display for drug identification, name, specifications, quantity, and operating instructions

#### APPLICATION

Clinical Ward and Central Pharmacy

#### MEDICAL TYPES

High-Risk, High-Value, Blister Packs, Boxed Drugs, Ampoules, and Vials

<b>Code</b>	WAT908510
<b>Description</b>	A2310 Auxiliary
<b>Width</b>	810mm
<b>Depth</b>	672mm
<b>Height</b>	1938mm 2067mm (with camera)
<b>Power Interface</b>	AC, 100-240VAC, 320W
<b>Network Port</b>	Wired ethernet port
<b>UPS</b>	Back up UPS, 1000VA

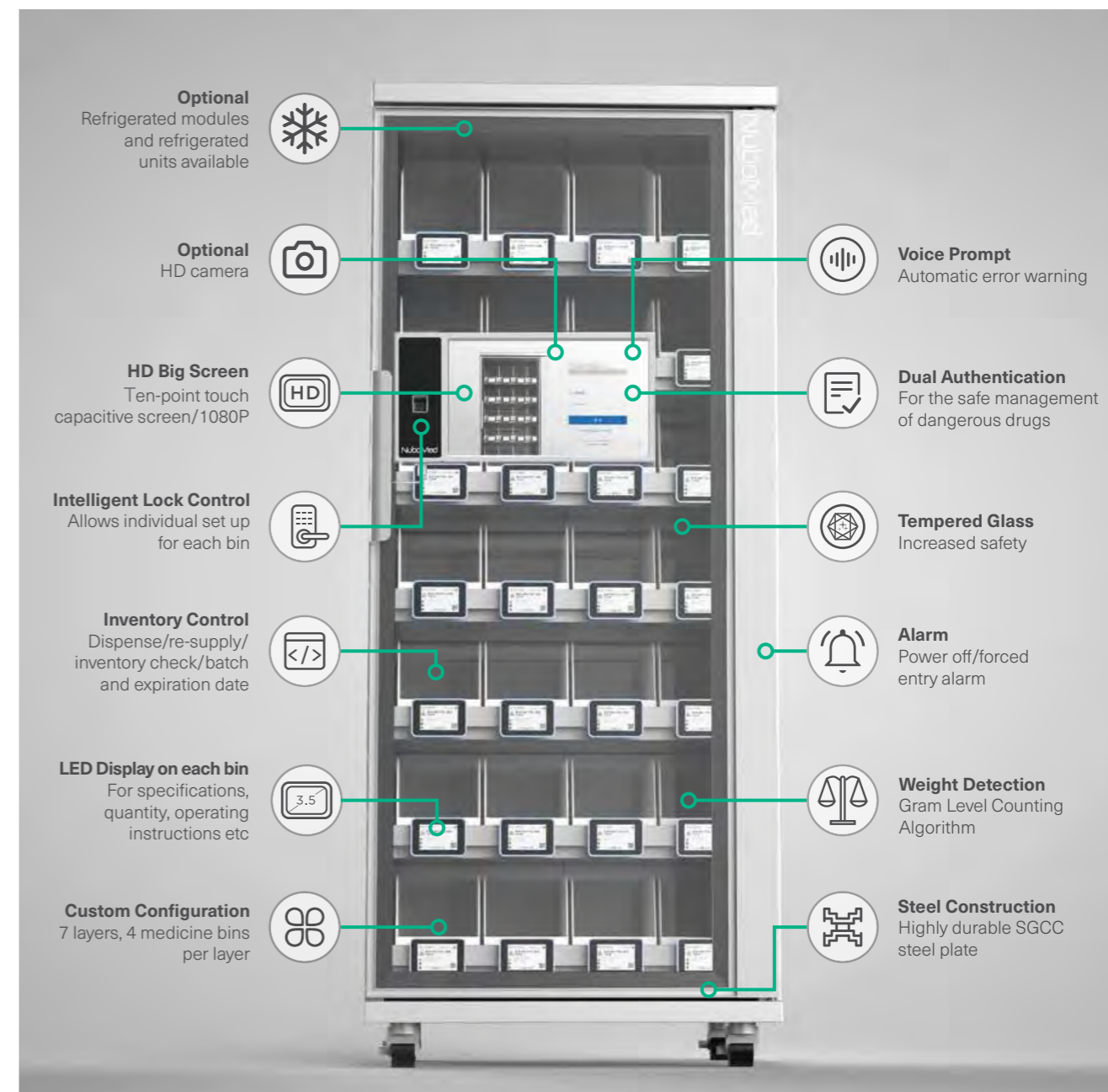

- Optional** Refrigerated modules and refrigerated units available
- Optional** HD camera
- HD Big Screen** Ten-point touch capacitive screen/1080P
- Intelligent Lock Control** Allows individual set up for each bin
- Inventory Control** Dispense/re-supply/inventory check/batch and expiration date
- LED Display on each bin** For specifications, quantity, operating instructions etc
- Custom Configuration** 7 layers, 4 medicine bins per layer
- Voice Prompt** Automatic error warning
- Dual Authentication** For the safe management of dangerous drugs
- Tempered Glass** Increased safety
- Alarm** Power off/forced entry alarm
- Weight Detection** Gram Level Counting Algorithm
- Steel Construction** Highly durable SGCC steel plate

## A2310 S Medication Auxiliary Cabinet Nubomed



### INTELLIGENT MEDICATION CABINET (PACKED MED) TYPE A WITHOUT AUTO-COUNTING

Suitable for dispersed satellite inpatient area medication management. Includes seven levels, 28 manual counting enclosures with LED display and glass door.

- High-strength aluminium alloy and metal with anodised surface
- Intelligent lock control - authorised user set up for cabinet lock access, allows individual set up for each bin
- Layers - 7 layers, 4 medicine bins per layer
- Door type - 1 transparent tempered safety glass door
- Speaker - voice prompt
- Intelligent real-time quantity and specification monitoring, accommodates oral, ampoule, vial, boxed, and blister pack medicines
- Intelligent display - each bin is equipped with a colour LED display for drug identification, name, specifications, quantity, and operating instructions

#### APPLICATION

Clinical Ward and Central Pharmacy

#### MEDICAL TYPES

High-Risk, High-Value, Blister Packs, Boxed Drugs, Ampoules, and Vials

<b>Code</b>	WAT908520
<b>Description</b>	A2310 S Auxiliary
<b>Width</b>	810mm
<b>Depth</b>	672mm
<b>Height</b>	1938mm 2067mm (with camera)
<b>Power Interface</b>	AC, 100-240VAC, 320W
<b>Network Port</b>	Wired ethernet port
<b>UPS</b>	Back up UPS, 1000VA

Led Display



Inventory Control



Custom Configuration



# Hospital Mortuary and Funeral Home

---

Aidacare supply a great range of Funeral Home and Mortuary Equipment. The range consists of Lifting Equipment, Trolleys, and Instrument Carts plus a great range of accessories. Our range has been designed to be robust enough to handle the rigors of the environment whilst focusing on ease of cleaning and adjustability for the user.

Aidacare are proud to represent Sova Motion as our key equipment partner in this sector.

## Sova Chapel Trolley



- Easily transfer coffin without having to manually lift
- High / low operation accommodates any vehicle height
- Electric high / low operation. Optional skirt allows trolley to transform to a chapel stand
- Electric coffin and casket brake front and rear
- Zinc epoxy coated frame
- Electric floor brake
- 200mm diameter rubber tyres for smooth transfer
- Linak electrics 24 volt system

### OPTIONAL

-  Fabric Skirt - Pair for Chapel Trolley (FUN100620) (FUN100630) Extra Wide

SWL 250kg

SWL 350kg

Code	Description	Length	Width	Height
FUN100600	Chapel Trolley - with Skirt	1200mm	505mm	500 - 900mm
FUN100610	Chapel Trolley - Extra Wide - with Skirt	1200mm	655mm	500 - 900mm

## Aidacare Aspire A320 Aluminium Bariatric Lifter



- Ergonomic handles provide multiple grip points to suit carers of different heights and strengths
- Ergonomic handset with the latest slimline technology from linak, intuitive control panel, battery, and service indicator lights
- Powered leg function opens and closes the legs for lifting stability or accessibility
- Quick release yoke attachment and padded yoke
- Build quality strong powder coated aluminium frame with industry leading linak electronics and warranty provision
- Safety critical features include emergency stop button, emergency lowering and anti-entrapment technology, with both patient and caregiver safety at heart
- Intelligent diagnostics state of the art linak jumbo care control system
- 2x 100mm front castors for reduced rolling resistance under high load, 2x 125mm rear locking castors for safety and manoeuvrability

SWL 320kg

1 YEAR WARRANTY Battery

3 YEARS WARRANTY Electronics

5 YEAR WARRANTY Frame



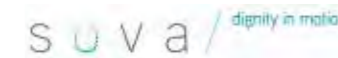

Code	Description	Overall Height	Overall Length	Overall Width	Lifter Weight
LSS390630	A320 - Bariatric Lifter - Aluminium	2165mm	1505mm	765mm	63kg

## CIRRUS<sup>500</sup> Ceiling Track Hoist



- Ceiling track system
- 270° rotation
- Inline cable management system
- Adjustable length straps
- Heavy duty stainless steel hardware
- Ergonomic finger tip control pendant
- 2 speed electric high / low operation
- Parallel strap lifting mechanism
- Head strap support

### OPTIONAL

-  Weight Scale - Factory Fitted (LIC362130)
-  Pivot Trolley 270° (LIC362110)
-  Cable Management - Priced per Metre (LIC362120)
-  Adjustable PVC Head Support (LIC362140)

SWL 500kg

3 YEARS WARRANTY Electric

10 YEAR WARRANTY Frame

Code	Description	Overall Height	Overall Length	Overall Width	Lifting Range
LIC362100	CIRRUS 500 - Ceiling Track Hoist	300mm	470mm	1200mm	3000mm

## Coffin/Body Tray Trolley - 300kg

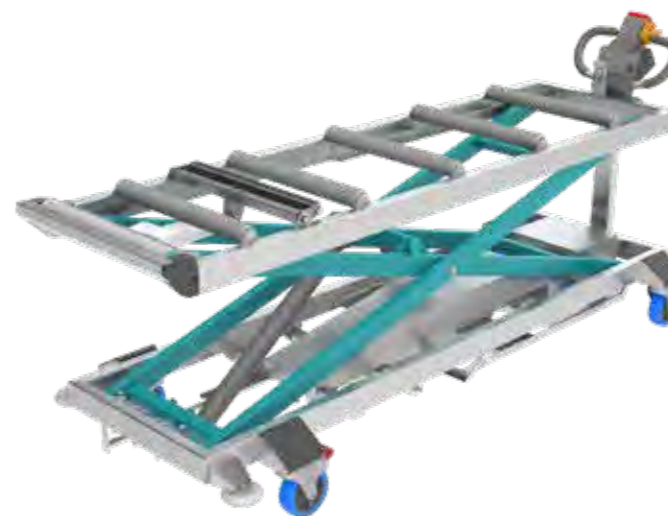
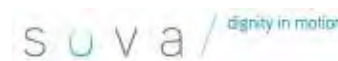

- Dual purpose roller design for coffin and body trays
- Handset high / low operation
- Heavy duty ball bearing rollers
- Epoxy powder coated frame
- Height adjustable push handle
- Electric high / low operation
- Removable rechargeable battery pack
- Electric body tray and coffin brake
- Electric body tray drain angle function
- 150mm lockable castors
- 2105mm long with body tray

SWL 300kg

Code	Description	Length	Width	Height
FUN100210	Coffin/Body Tray Trolley	2055mm	640mm	470 - 1825mm
FUN100220	Coffin/Body Tray Trolley - Side Loading	2320mm	640mm	470 - 1825mm
FUN101050	Coffin/Body Tray Trolley - Tray Roller	2170mm	640mm	470 - 1825mm
FUN101060	Coffin/Body Tray Trolley - Electric Drive Unit	2320mm	640mm	470 - 1825mm
FUN101070	Coffin/Body Tray Trolley - Drive Unit - Side Loading	2340mm	640mm	470 - 1825mm
FUN101080	Coffin/Body Tray Trolley - Drive Unit and Electric Tray/Coffin Roller	2435mm	640mm	470 - 1825mm



### Coffin/Body Tray Trolley - Concealment - 300kg



- Rubber coated rollers for coffin and body trays
- Linak actuators
- Heavy duty ball bearing rollers
- Ergonomic push / pull handle
- Electric high / low operation
- Electric coffin / tray brake
- Maintenance free battery pack
- 150mm locking castors



Code	Description	Length	Width	Height
FUN101120	Coffin/Body Tray Trolley - Concealment - Drive Unit	2320mm	780mm	470 - 1825mm
FUN101130	Coffin/Body Tray Trolley - Concealment - Drive Unit - Side Loading	2320mm	780mm	470 - 1825mm
FUN101140	Coffin/Body Tray Trolley - Concealment - Drive Unit - Tray Roller	2435mm	780mm	470 - 1825mm

### Coffin/Body Tray Trolley - 500kg



- Rubber coated rollers with heavy duty ball bearing rollers
- 150mm metal locking castors and flat free tyres
- Stainless steel top and bottom frame
- Electric over hydraulic high / low operation
- Electric coffin / tray brake
- Maintenance free battery pack with battery level indicator
- Electric drive unit and electric drive wheel retractor
- Variable speed controller
- Suspension system for uneven surfaces and superior traction

**OPTIONAL**



Code	Description	Length	Width	Height
FUN100120	Coffin/Body Tray Trolley - Drive Unit	2540mm	870mm	400 - 1900mm
FUN100130	Coffin/Body Tray Trolley - Drive Unit and Tray Drive Roller	2540mm	870mm	400 - 1900mm
FUN100140	Coffin/Body Tray Trolley - Drive Unit and Weigh scale	2540mm	870mm	400 - 1900mm
FUN100150	Coffin/Body Tray Trolley - Drive Unit, Tray Drive Roller and Weigh scale	2540mm	870mm	400 - 1900mm



### Cadaver Tray - Bariatric - 500kg



- Stainless steel construction
- Push/pull handles both ends
- Angled sides allow for easy side transfer
- Sub-frame construction
- Angled corners allow for easy cleaning and fluid removal



Code	Description	Length	Width	Height
FUN100810	Cadaver Tray - Bariatric	2090mm	750mm	95mm
FUN100820	Cadaver Tray - Bariatric with drain			

### Single Bay Rack - 3 & 4 tier

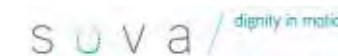

- Open designs allows access for cleaning
- Rigid flat pack construction
- Stainless steel construction
- Adjustable stainless steel feet
- Optimised tier height
- Custom size can be designed
- 300kg SWL per bay - 300 Series
- 500kg SWL per bay - 500 Series
- Front and rear retainers



Code	Description	Length	Width	Height
FUN100520	Single Bay Rack - 3 tiers	2110mm	740mm	1690mm
FUN100530	Single Bay Rack - 3 tiers - Side loading	740mm	2180mm	1690mm
FUN100560	Single Bay Rack - 4 tiers - Cadaver Tray Storage only	2110mm	740mm	1900mm

### Single Bay Rack - 3 & 4 tier - Mobile

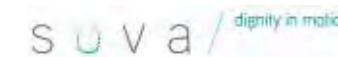

- Open designs allows access for cleaning
- Rigid flat pack construction
- Stainless steel construction
- 100mm total lock castors
- Optimised tier height
- Custom size can be designed
- 300kg SWL per bay - 300 Series
- 500kg SWL per bay - 500 Series



Code	Description	Length	Width	Height
FUN100850	Single Bay Rack - 3 tiers	2110mm	740mm	1130mm
FUN100870	Single Bay Rack - Bariatric - 3 tiers	2110mm	955mm	1250mm
FUN100900	Single Bay Rack - 4 tiers			
FUN100920	Single Bay Rack - Bariatric - 4 tiers			

## Sova Lifting Straps



- To be used in conjunction with the Morgue Sling (4 bands) to allow optimal transfers in morgue applications
- Suitable for use with fixed ceiling lifts
- Compatible with Cirrus 500, Liko Ceiling Hoists, Liko Patient Lifters, Prism Ceiling Hoists, Aidacare A320, A205, and 200 Patient Lifters

Code	Description	Length	Width
LIC362400	Lifting Strap - Short - 2 eyelets - HDPE Plastic	1250mm	50mm
LIC362410	Lifting Strap - Long - 2 eyelets - HDPE Plastic	1475mm	50mm

## Lifter Spreader Bar - 200kg



- Optional Stretch Leveller allows for quick adjustment
- Can be used with a full lift sheet or with 4 lift straps
- Lightweight design weighing at 7.2kg
- Optional quick-release hook system is also available
- Compatible with Liko patient lifters and Liko ceiling hoists, Prism ceiling hoists, Aidacare A320, A205 and 200 lifters



Code	Description	Length	Width	Height
LSS394920	Mortuary Spreader Bar - 200kg	1263mm	617mm	227mm

## Lifter Spreader Bar - 360kg



- Multiple hook positions - 13 total
- Simple and fast attachment
- Epoxy powder coat finish
- Central hanging pivot point
- Mild steel heavy wall tubular frame
- Suitable for use with ceiling mounted lift systems and floor hoists



Code	Description	Length	Height
LIC362300	Mortuary Spreader Bar - 363kg	1580mm	165mm

## Ceiling Hoist - Motor - CP200 Portable



- Slimline, low profile, padded carry bar that has six loop attachments as standard (four-point hook optional). Different width carry bars also available
- Low profile hoist unit is unobtrusive and provides greater lifting height
- All lifting and traversing operations have soft start / stop to ensure smooth transfers for the patient
- Quick release sling bar



Code	Description	Suits
LIC350105	CP200 Portable Ceiling Hoist	Ceiling Hoist Gantry - LIC352120

## Ceiling Hoist - Bariatric C380 Power Traverse



- Carry bar fitted with Quick Release System for simple interchange of carry bars
- Emergency stop / emergency lower
- Smooth stop start
- Bariatric four point carry bar
- Low profile hoist unit provides a great lift height



Code	Description	Suits
LIC350260	C-380P Power Traverse (Carry Bar Separate)	Installed Ceiling Hoist Track - LIC353120K

## Ceiling Hoist - Prism - Transactive Xtra Fixed



- Large array of configurations, catering to changing needs
- Digital display screen
- Return to Charge (RTC) option
- Manual window and raising allows for use during a power outage
- Low profile hoist unit is unobtrusive and provides greater lifting height
- Pneumatic handset is ideal for use in wet environments
- Emergency lowering
- Locking latches to secure slings in place for all lifts
- All lifting and traversing operations have soft start/stop to for smooth transfers
- Available in manual or powered traverse options



Code	Description	Suits	Height
LIC350170	Ceiling Hoist - Transactive - Manual Traverse & Carry bar	Installed Ceiling Hoist Track - LIC353120K (ALL)	Up to 2080mm
LIC350180	Ceiling Hoist - Transactive - Powered Traverse & Carry bar		
LIC350210	Ceiling Hoist - Transactive - Power Traverse & Carry bar		
LIC350182	Ceiling Hoist - Prism - TXE200D (C450) - Powered - Return to Charge - 200kg		



## FreeSpan Gantry



- FreeSpan™ SR (straight-rail) is a flexible alternative for most overhead-lift situations
- The lift system is freestanding, and since it is not affixed to the walls or the ceiling, there are no special strength requirements for those structures
- FreeSpan™ SR is made of aluminium and many different rail lengths are available
- Choose between using Multirall™ or Likorall™ lift units
- FreeSpan™ SR is assembled without tools and is equipped with wheels, which facilitate positioning
- The wheels also make the lift system easy to move between different rooms
- FreeSpan™ is also available in a traverse-model: FreeSpan™ Traverse, a unique, freestanding system that enables lifting, and transfer of patients between many different lifting points

### 3M KIT INCLUDES:

- FreeSpan Side Support - Wheels + Charger plate parking bracket for sling bar
- FreeSpan Rail 3m - with Likorall Trolley - 250kg
- Ceiling Hoist - Likorall 250 ES - White 250kg SWL
- Spreader Bar - Like Universal SlingBar 450 with Quick-release Hook - max 300kg
- Hand Control - Likorall S, ES, 2 button (for lifting)
- Battery Charger - LikoRall and multirall (24v/0,6 A)

### 5M KIT INCLUDES:

- FreeSpan Side Support - Wheels + Charger plate parking bracket for sling bar
- FreeSpan Rail 5m - with Likorall Trolley - 200kg
- Ceiling Hoist - Likorall 242 S R2R - White 200kg SWL
- Spreader Bar - Like Universal SlingBar 450 with Quick-release Hook - max 300kg
- Hand Control - LikoRall S, ES, 2 button (for lifting)
- Battery Charger - Likorall and multirall (24v/0,6 A)



Code	Description
LIC360730	FreeSpan Lift System - 3M Kit
LIC360740	FreeSpan Lift System - 5M Kit

## Clax Cart Trolley



- Ideal for transporting small to medium size materials
- 2 tier folding trolley
- Lightweight and fully portable
- Foot brake and removable wheels
- Extra boxes available
- 46 litre capacity
- Safe working load upper tray 20kg, lower tray 40kg
- Folded Dimensions 670 x 470 x 110mm

Code	Description	Length	Width	Height
WAT758020	Folding Trolley - Clax w/ crate	890mm	550mm	1030mm
WAT758021	Crate for Clax trolley	890mm	550mm	1030mm

## Grave Spreader



- Epoxy powder coated
- Adjustable width settings

Code	Description
FUN100730	Casket Lowering System - Manual

## Casket Lowering System

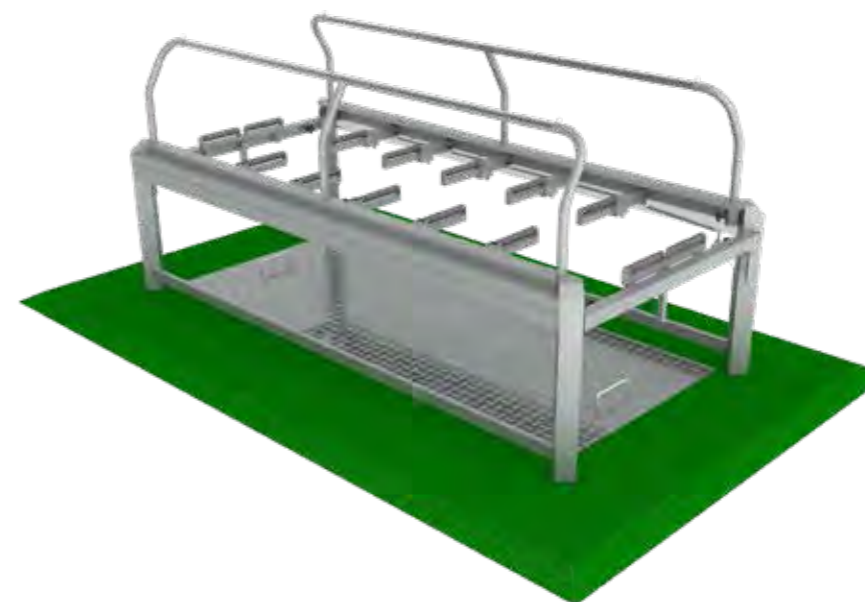
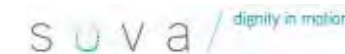

- Strap lowering aid
- Lever action swing away casket rollers
- Epoxy powder coated steel frame
- Lightweight aluminium surround
- End stopper/guide
- Safety rail
- Heavy duty construction
- Grave surround to prevent cave-ins
- Fabric skirt - optional



Casket lowering device



Storage & transport trailer



Grave surround

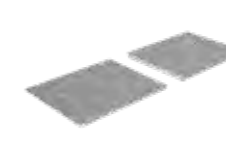

Grave surround covers



Skirt



Code	Description
FUN100700	Casket Lowering System - Manual
FUN100710	Casket Lowering System - Electric
FUN100720	Aluminium grave surround to suit casket lowering system
Available upon request	Grave Surround Covers - Set
Available upon request	Storage and Transport Trailer
Available upon request	Skirt



# Bariatric

---

At Aidacare we've seen an increased need for equipment with a heavier weight-bearing capacity. We've put together this guide to help our customers and their carers understand what is available from Aidacare's XXL Bariatric range. A client is deemed to be Bariatric when they weigh over 125kg and/or require a seat width greater than 50cm. This means they need to be careful when selecting medical equipment to ensure that it is appropriate and safe.

Aidacare's range of XXL Bariatric equipment is engineered to be more robust than our standard range. This increased build-quality results in more durable products that help ensure the safety and independence of our customers. Aidacare's wide range of XXL Bariatric equipment provides our customers with an extensive choice of brands and styles at an affordable price.

# Bariatric Products

MALVESTIO Botero Bariatric Ward Bed



SWL 400kg see page 8

MALVESTIO Botero Bariatric Static Mattress



SWL 400kg see page 8

ASPIRE Bariatric Static Mattress



SWL 300kg see page 25

ASPIRE Weight Bearing Platform Commode (600mm)



SWL 400kg see page 37

ASPIRE Bariatric Shower Commode



SWL 350kg see page 38

ASPIRE MAXI Shower Chair



SWL 310kg see page 40

# Bariatric Products

ASPIRE MAXI Shower Stool



SWL 310kg see page 41

ASPIRE MAXI Over Toilet Aid



SWL 310kg see page 41

SUPER HEAVY DUTY Wheelchair



SWL 318kg see page 50

SEATING MATTERS Sorrento Chair



SWL 294kg see page 65

ASPIRE MAXI Adjustable Day Chair



SWL 310kg see page 15

2 SECTION Examination Couch



SWL 250kg see page 142

# Bariatric Products

LIKO Viking XL Patient Lifter



SWL 300kg see page 85

ASPIRE A320 Aluminium Bariatric Lifter



SWL 320kg see page 91

LIKO LikoGuard XL Fixed Lifting Hoist



SWL 363kg see page 103

PRISM MEDICAL C830 Bariatric Fixed Lifting Hoist



SWL 380kg see page 103

LIKO Bariatric Slings



SWL 500kg see page 88

ASPIRE Bariatric Slings



SWL 300kg see page 93

# Bariatric Products

PRISM MEDICAL UK Freespan Gantry



SWL 500kg see page 166

SOVA Cirrus 500 Ceiling Track Hoist



SWL 500kg see page 161

SOVA Coffin/Body Tray Trolley



SWL 500kg see page 162

SOVA Coffin/Body Tray Trolley - Concealment



SWL 350kg see page 162

SOVA Cadaver Tray - Bariatric

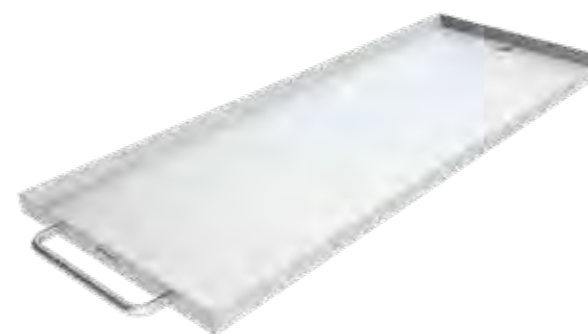

SWL 500kg see page 163

SOVA Single Bay Rack 3 & 4 tier - Mobile



SWL 500kg see page 163









ACA27.03 2023