



VIDA WHEELCHAIR

Attendant Propelled | Self Propelled

USER MANUAL



Congratulations and thank you for choosing an Aspire Vida Wheelchair.

This product has been designed to offer the maximum in comfort, safety and lightweight portability. Aspire Vida Wheelchairs are suitable for indoor and limited outdoor use.

It is important that you read this user manual carefully before using your new wheelchair.

TABLE OF CONTENTS

1. Symbols Used In This Manual _____	4
2. Symbols Used On The Product _____	4
3. Intended Use _____	5
4. Product Description _____	5
5. Warnings _____	6
6. Product Specifications _____	6
7. List Of Components _____	7
8. Assembly Instructions _____	8
9. Preliminary Checks _____	9
10. General Operation _____	9
11. Adjusting Your Wheelchair _____	13
12. Optional Accessories _____	14
13. Troubleshooting _____	16
14. Care & Maintenance _____	17
15. Warranty _____	18
16. Compliance _____	18
17. Service Maintenance & Customisation _____	18
18. Recycling Information _____	18
19. Manufacturer, UK Representative And Importer Details _____	19

CE This product features the CE mark, in compliance with the Medical Devices Regulation 2002 (as amended) Class 1, and the Medical Device Regulation 2017/745.

**UK
CA** This product Features the UKCA mark, in compliance with Part II UK MDR 2002 (as amended) Class 1.

© Aidacare Limited 2023

No part of this user manual may be copied, distributed, reproduced, scanned or stored on any electronic database, whether in whole or in part in any form or by any means.

Due care has been taken to ensure all the information contained in this user manual is correct at the time of printing. All measurements, pictures, colours and weight capacities are to be used as a guide only. We reserve the right to modify the design or appearance of any product displayed in this user manual without prior notice.

1. SYMBOLS USED IN THIS MANUAL











The symbols below are used throughout this user manual and on the product to identify warnings and important information. It is very important for you to read them and understand them completely.

 **WARNING!** Indicates a potentially hazardous condition/situation. Failure to follow designated procedures can cause either personal injury, component damage or malfunction. On the product, this icon is represented as a black symbol on a white triangle with a black border.

 **ALWAYS!** These actions should be performed as specified. Failure to perform mandatory actions can cause personal injury and/or equipment damage. On the product, this icon is represented as a white infinity symbol on a black dot with a white border.

 **DO NOT!** These actions are prohibited. These actions should not be performed at any time or in any circumstances. Performing a prohibited action can cause personal injury and/or equipment damage. On the product, this icon is represented as a white symbol with a black circle and black slash.

2. SYMBOLS USED ON THE PRODUCT

 aspire VIDA WHEELCHAIR		AUSTRALIA Aidacare Pty Ltd ABN 40 134 833 Building 3A, 1 Moorebank Avenue, Moorebank NSW 2170 1300 133 120 product@aidacare.com.au		    	 
# MWS449850	 UNITED KINGDOM Aidacare Ltd Registration 13785408 Arcadia House, Maritime Walk, Ocean Village, Southampton SO14 3TL 01622 541235 info@aidacare.co.uk	 European Healthcare & Device Solutions (Ireland) Ltd Stratton House, Bishopstown Road Cork T12 Y9TC Ireland info@europeandevicesolutions.eu			
SN	 MADE IN PRC It is recommended that you have this product serviced every 12 months				

- | | | | |
|---|------------------------|---|---------------------------------|
|  | Product Code |  | UKCA Mark |
|  | Serial Number |  | Safe Working Load |
|  | Manufacturer |  | Read User Manual |
|  | Importer |  | Caution |
|  | Country of Manufacture |  | Medical Device |
|  | Not Crash Tested |  | Authorised Representative in EU |
| | |  | CE Mark |

3. INTENDED USE

This product is specifically designed for individuals who, due to a wide variety of reasons, have limited mobility or are unable to walk. This product should be used as a tool to assist with mobility or walking difficulties.

Attendant Propelled Wheelchairs are able to be propelled by an attendant with the push handles. This wheelchair is designed for indoor and limited outdoor use. When used outdoors this wheelchair must remain on sealed, level terrain (examples include but are not limited to shopping centres, medical centres, flat and level footpaths, and environments with accessibility-focused layouts). When using outdoors it is suggested that anti-tip wheels are fitted.

Self Propelled Wheelchairs are able to be propelled by a user with the self-propelling wheels or by an attendant with the push handles. This wheelchair is designed for indoor and limited outdoor use. When used outdoors this wheelchair must remain on sealed, level terrain (examples include but are not limited to shopping centres, medical centres, flat and level footpaths, and environments with accessibility-focused layouts). When using outdoors it is suggested that anti-tip wheels are fitted.

 **WARNING!** This wheelchair is intended to bear the weight of an occupant through its wheels during propulsion and when stationary. It is **NOT** designed to be lifted/carried with an occupant in the seat and doing so may cause serious injury or death.

 **WARNING! Transportation in a Vehicle**
 This wheelchair is NOT designed or tested to carry an occupant for transportation in a motor vehicle. When travelling in a motor vehicle the occupant should sit in the vehicle seat with seatbelt fastened and the wheelchair be folded and securely stored in the luggage compartment.

4. PRODUCT DESCRIPTION

Aspire Vida - Attendant Propelled



The Aspire Vida - Attendant Propelled model is four wheel wheelchair with a cross folding frame. The product is made from aluminum, so it is light and easy to store or transport. This wheelchair offers great maneuverability, stability and it's leg rests are height adjustable for a customised fit. It is equipped with a padded mesh seat and backrest, push handles, 13 inch rear wheels, swing-away legrests and padded armrests.

Aspire Vida and Vida X - Self Propelled











The Aspire Vida SP and VidaX - Self Propelled models are four wheel wheelchairs with a cross folding frame. The product is made from aluminum, so it is light and easy to store or transport. These wheelchairs offer great maneuverability, stability and their leg rests are height adjustable for a customised fit. They are equipped with a padded mesh seat and backrest, push handles, 22 inch rear wheels, swing-away legrests and padded armrests.

5. WARNINGS

MAXIMUM WEIGHT CAPACITY – 135KG / 21st

-  **DO NOT** exceed maximum user weight. This weight limit includes any accessories, shopping or other personal items that may be carried on the chair. The maximum weight capacity is defined with respect to a typical body shape, where body mass is evenly distributed. Users with dysmorphic body shapes or amputees should be assessed by an accredited healthcare professional prior to choosing/using this wheelchair.
-  **DO NOT** stand on the foot plates as the wheelchair may tip forwards. The foot plates are not designed to be a weight bearing surface.
-  **DO NOT** use the wheelchair on escalators, even if accompanied by an attendant.

6. PRODUCT SPECIFICATIONS

MODEL	OVERALL LENGTH	OVERALL WIDTH	OVERALL HEIGHT	SEAT DEPTH	SEAT WIDTH	ANTERIOR SEAT HEIGHT	POSTERIOR SEAT HEIGHT	BACKREST HEIGHT	ARMREST HEIGHT	SAFE WORKING LOAD	REAR WHEEL
	mm / inches	mm / inches	mm / inches	mm / inches	mm / inches	mm / inches	mm / inches	mm / inches	mm / inches	kg / stone	inches
											
Vida - AP	995 / 39	655 / 26	930 / 36.5	420 / 16.5	450 / 18	495 / 19.5	445 / 17.5	430 / 17	200 / 8	135 / 21	13
Vida - SP	1030 / 40.5	685 / 27	930 / 36.5	420 / 16.5	450 / 18	495 / 19.5	445 / 17.5	430 / 17	200 / 8	135 / 21	22
Vida X - SP	1040 / 40.9	680 / 26.7	950 / 37.4	420 / 16.5	450 / 17.7	500 / 19.6	460 / 18.1	890 / 35	700 / 27.5	135 / 21	22

MINIMUM CHAIR WEIGHTS:

 **8.8kg
19.4lb** Aspire Vida Attendant Propelled

 **7.5kg
16.6lb** Aspire Vida Self Propelled

 **12.2kg
26.8lb** Aspire Vida X Self Propelled

7. LIST OF COMPONENTS

VIDA / VIDA X

- 1 13" Rear Wheels (AP) | 22" Rear Wheels (SP)
- 2 7" Front Wheels
- 3 Wheel fork
- 4 Attendant Brakes
- 5 Height Adjustable Legrests
- 6 Folding Foot Plates
- 7 Padded Armrests
- 8 Padded Seat Upholstery
- 9 Folding Backrest with Padded Upholstery and Carry Pouch
- 10 Attendant Hand Grips
- 11 Frame Cross Bar
- 12 Legrest Removal Lever
- 13 Folding Backrest Lever

Aspire Vida Attendant Propelled

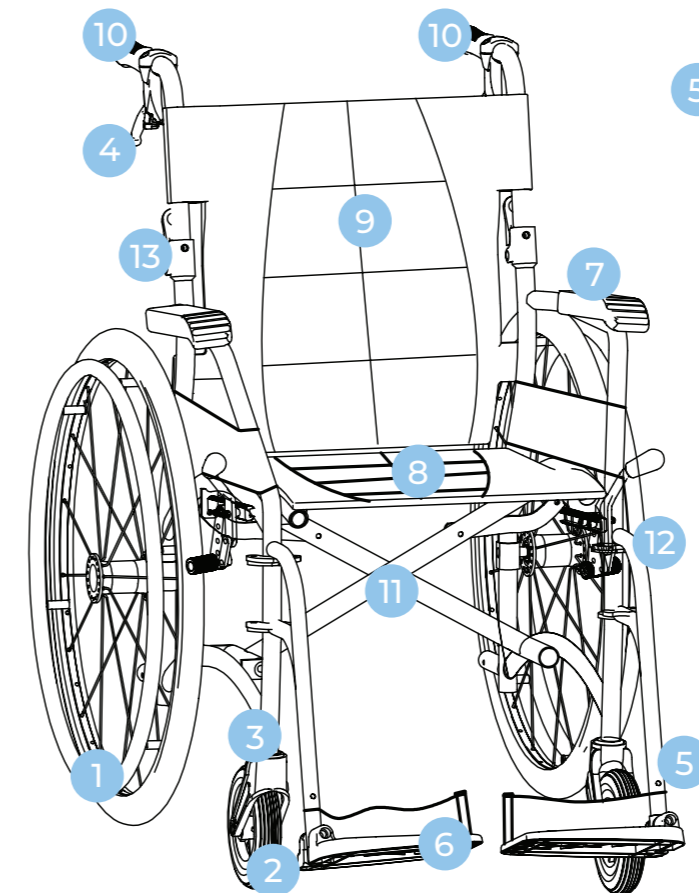
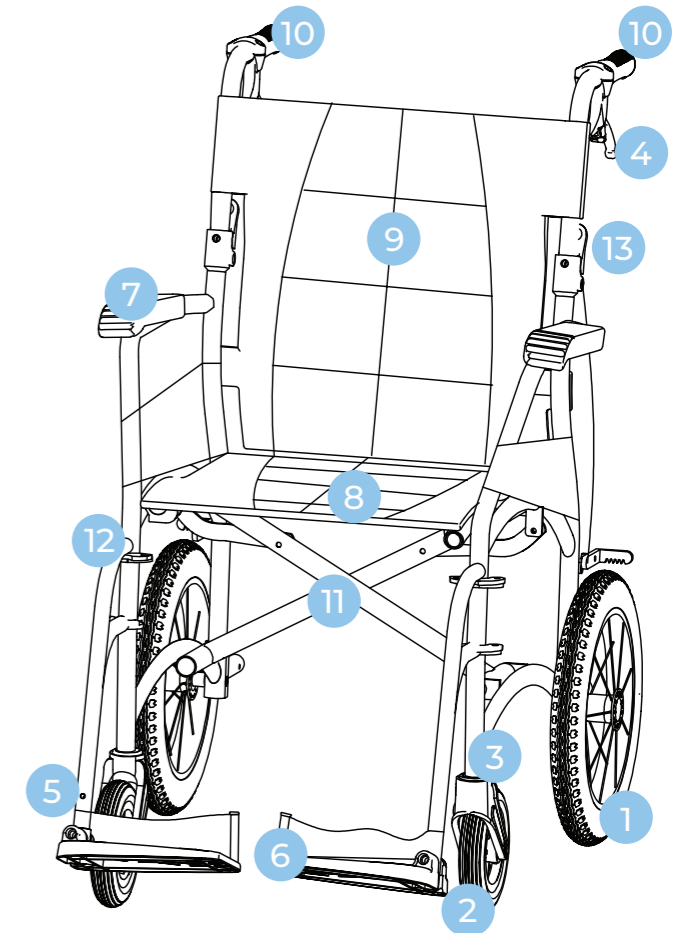

Aspire Vida/Vida X Self Propelled

8. ASSEMBLY INSTRUCTIONS

BOX CONTAINS:

Wheelchair frame fitted with rear wheels

- Wheelchair
- Left Legrest
- Right Legrest
- Allen Keys (4mm, 5mm)
- User Manual



When opening the carton, ensure it is done in a safe and careful manner. **DO NOT USE** a box cutter or sharp implement as this may damage the product. For WH&S purposes, lay the carton on its side with the top of the carton open and slide the plastic bag out containing the wheelchair.

- 1 Place the wheelchair on levelled ground. Then push down on the side rails of the seat until flat.

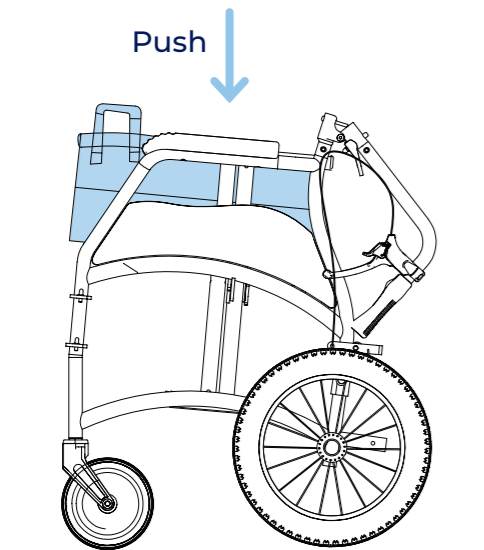

- 2 Flip up and click backrest into place. **IMPORTANT:** Ensure your fingers are kept clear from the pivoting mechanism.

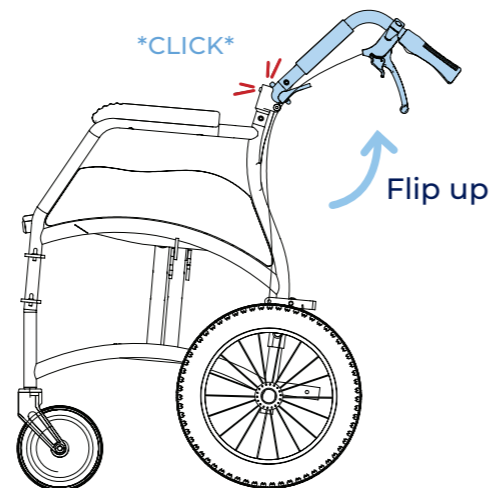

- 3 Wheelchairs come with a left and right legrest.
 - a Insert the legrest into the corresponding receiver at a 90° angle (as shown).
 - b Rotate legrest towards the centre until it clicks into place. Repeat for the other side.

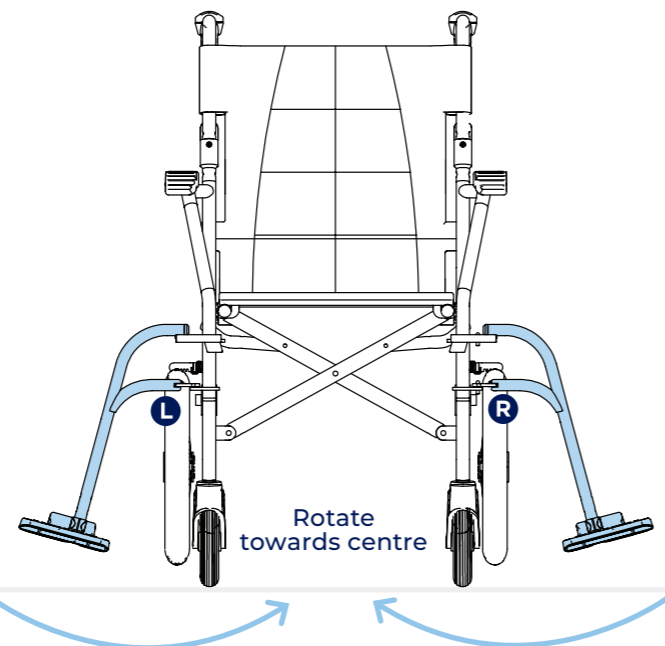

9. PRELIMINARY CHECKS

After assembling the wheelchair, these checks should be completed prior to initial use:

1. Check that the seating surface is locked into place, creating a flat support surface.
2. Check that rear wheels are locked in place.
3. Check that rear brakes engage and disengage.

10. GENERAL OPERATION

General Operation

It is very important that this wheelchair is used under guidance from all warnings or hazards listed in this product user manual. Key safety measures should be taken by both users and attendants when using this wheelchair:

- Avoid quick direction changes.
- Ensure your wheelchair is used on surfaces intended for its use.
- Ensure an attendant is available to assist at all times.

Lifting the Wheelchair

To fold your chair correctly follow the 'ASSEMBLY' instructions in reverse 3, 2, 1.

Then, use the carry handle on the seating surface to safely lift the wheelchair.



DO NOT lift the wheelchair with an occupant in the seat. This lifting guide is for safe handling of the wheelchair only.



WARNING

WARNING! DO NOT lift the wheelchair by holding it by the legrests or the armrests! Fold-up the legrests prior to lifting the chair.

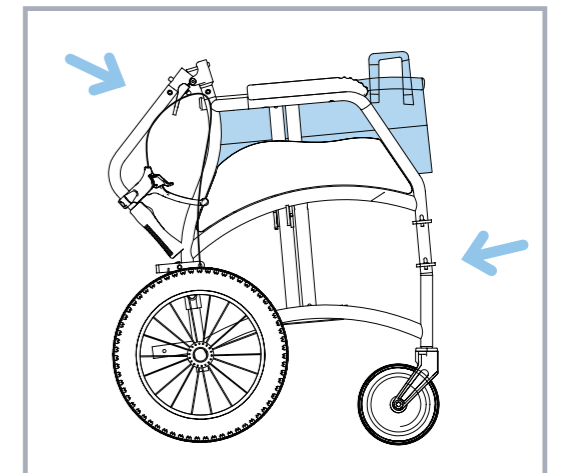

Transporting the Wheelchair

To transport this chair in a motor vehicle it is suggested that the backrest, seat and legrests are folded as per the "Lifting the Wheelchair" instructions above. This will help reduce the overall chair size in order to fit into the rear boot or backseat of a standard motor vehicle.



WARNING

WARNING! Aspire Vida Wheelchairs are **NOT** crash tested and **SHOULD NOT** ever be used as a means of transporting a user in a motor vehicle.

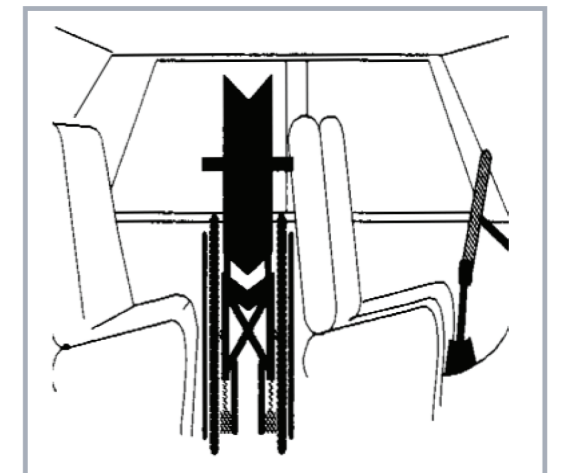

**Moving Wheelchair Up a Kerb
– With an Attendant**

1. Push the wheelchair up to the kerb **FEET FIRST**.
2. The attendant should push down on the rear foot peg to slightly incline the chair. **DO NOT** tilt the chair back with the push handles.
3. Once the front wheels are firmly on the ground above the kerb, the rear wheels should be pushed against the kerb to propel the entire chair to rest above the kerb.



WARNING

WARNING! This should only ever be done with an attendant and not performed by a user on their own. It is very important the above steps are followed to prevent injury to both the user and the attendant.

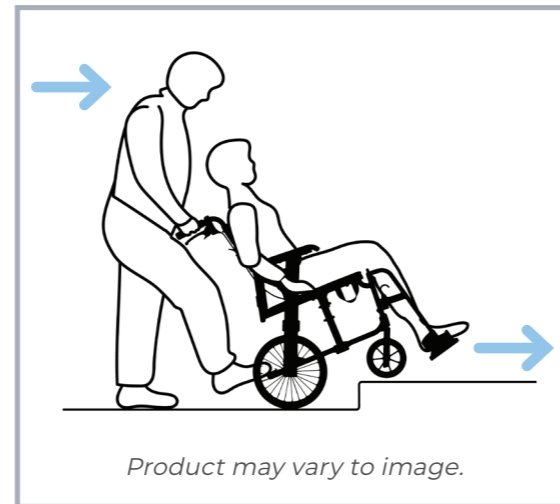

**Moving Wheelchair Down A Kerb Or Single Step
– With An Attendant**

1. Reverse the wheelchair up to the kerb **FEET LAST**.
2. The attendant should check for cars or obstructions prior to commencing the descent.
3. The attendant should slowly lower the rear wheels down to the road surface, ensuring not to tip the chair.
4. Once the rear wheels are firmly on the road surface, the front wheels should be slowly lowered onto the road surface.



WARNING

WARNING! This should only ever be done with an attendant and not performed by a user on their own. It is very important the above steps are followed to prevent injury to both the user and the attendant.

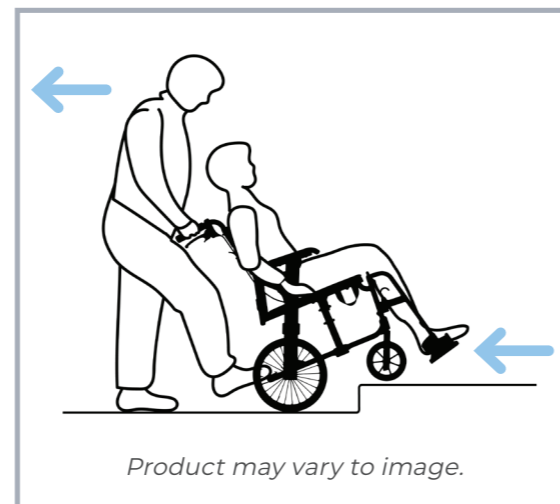

OTHER IMPORTANT WARNINGS



WARNING

Warning! Sloped or uneven terrain

This wheelchair is designed for use on flat-level surfaces. If encountering sloped or uneven terrain an alternative route should be sought. If impossible a carer should always be present, and use the attendant brakes to control speed and ensure the wheelchair to continue straight forward until reaching flat ground.



WARNING

Warning! Maintaining stationary position

When not propelling the wheelchair the brakes should be applied in the locked position at all times.



WARNING

Warning! Protecting hands when self-propelling

When slowing or braking the wheelchair using the self-propelling hand rims, heat can be created via friction. To protect the skin integrity of the hands, it is strongly suggested that the user wear wheelchair gloves.



WARNING

WARNING! DO NOT travels down kerbs or single steps without an attendant carer

NEVER attempt to transit down multiple steps with or without an attendant carer.



WARNING

WARNING! When self-propelling the wheelchair, it is strongly suggested that anti-tip wheels are fitted. If anti-tip wheels are in the raised position or not fitted to the chair an attendant carer should stand behind the wheelchair holding the handles.

SAFE USE



UNSAFE USE

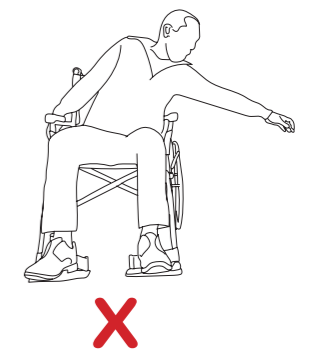
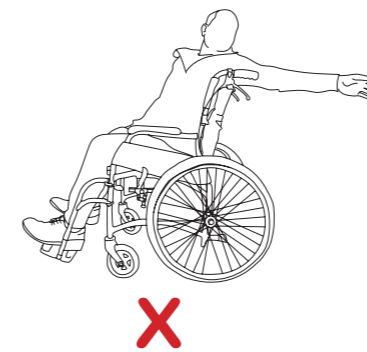

WARNING

Warning! Avoid reaching from within the wheelchair

To ensure the upright stability of the wheelchair, never reach for objects as this changes the centre of mass and may cause the chair to tip over in the direction of reaching. This warning relates to reaching in any direction outside the perimeter of the wheelchair.

ATTENDANT HANDBRAKE OPERATION

10.1 HOW TO ACTIVATE BRAKES

ACTIVATING BRAKES

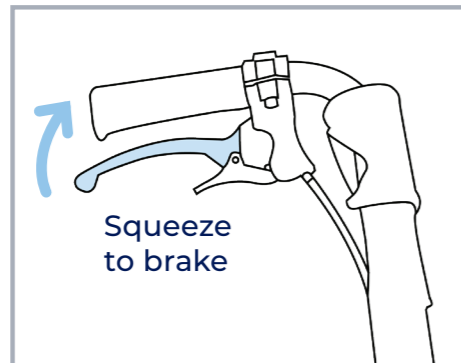

BRAKE: To engage brakes, squeeze the handbrake in an upwards direction.



RELEASE BRAKE: To disengage brakes, release the handbrake.

10.2 HOW TO LOCK CARER HANDBRAKES

LOCK / UNLOCK

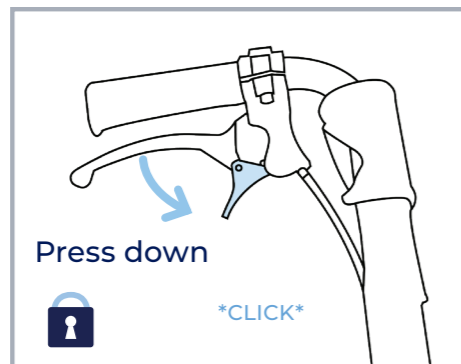

LOCK: To engage brakes, squeeze the handbrake in an upwards direction. Press down on the switch until it clicks, this will lock the brakes.

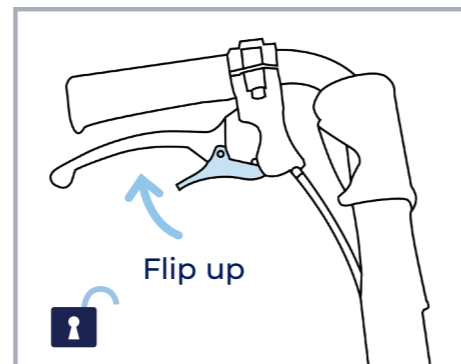

UNLOCK: To disengage brakes, flip the switch upwards.

10.3 HOW TO LOCK USER HANDBRAKES

LOCK / UNLOCK

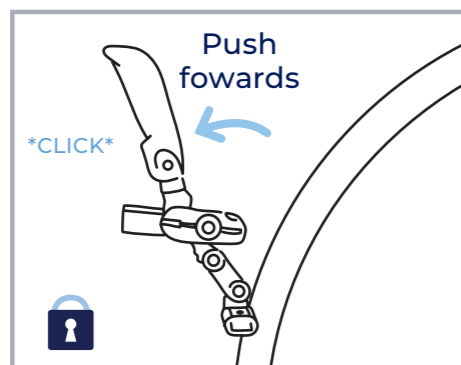

LOCK: To engage brakes, push the hand brake in a forwards direction until it clicks, this will lock the brakes.

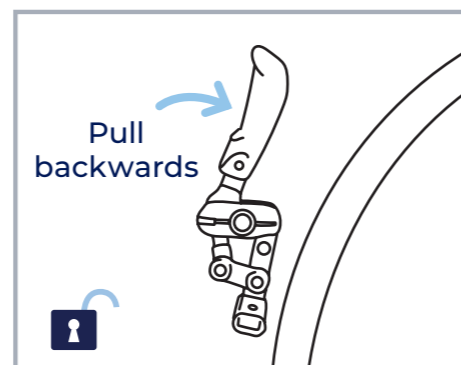

UNLOCK: To disengage brakes, pull the hand brake in a backwards direction.

11. ADJUSTING YOUR WHEELCHAIR

11.1 ADJUSTING LEGREST HEIGHT

- 1 Using a 5mm Allen key loosen the bolt and remove the centre pin.
- 2 Nominate the preferred height by raising or lowering footplate.
- 3 To secure, align the centre pin with the chosen hole and tighten.

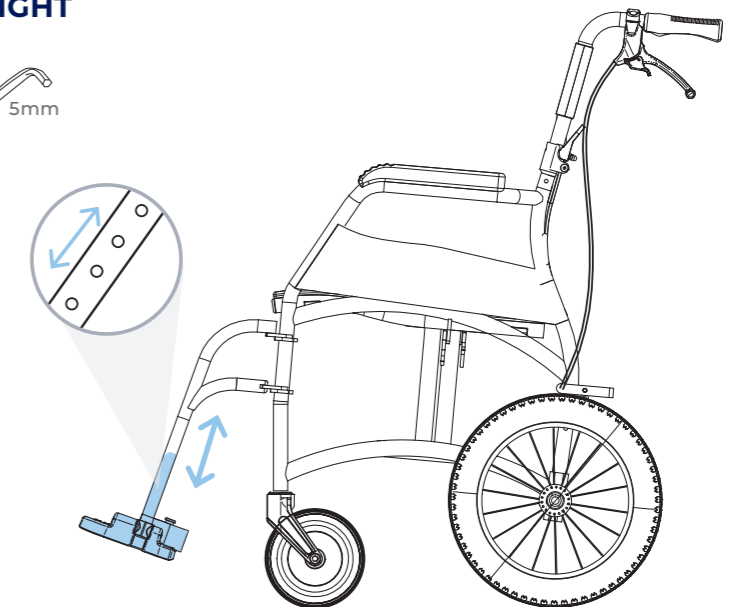

11.2 REMOVING LEGRESTS

- 1 Pull release latch outwards and hold the latch, simultaneously rotating the legrest (away from the centre of the chair) in an outwards direction until loose. Repeat for the other side.

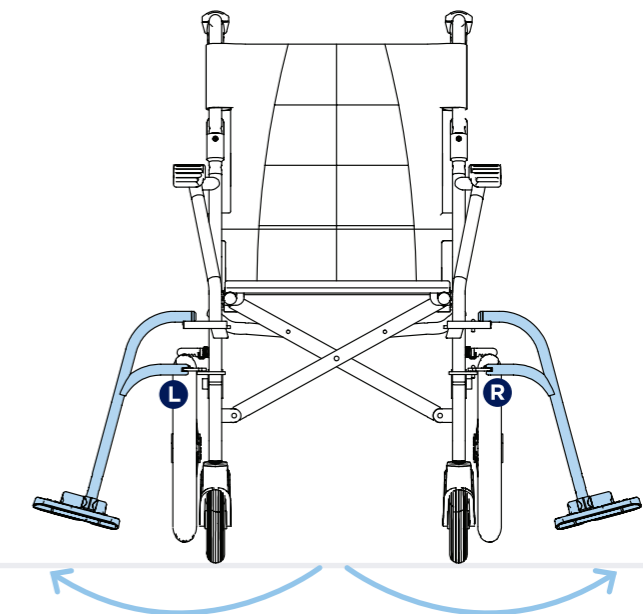

12. OPTIONAL ACCESSORIES

LAP BELT

WCA848300



TOOLS REQUIRED

5mm Phillips head screwdriver

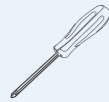

INSTALLING SEAT BELT

- 1 Remove screws (both sides) from the lower backrest mounting point.

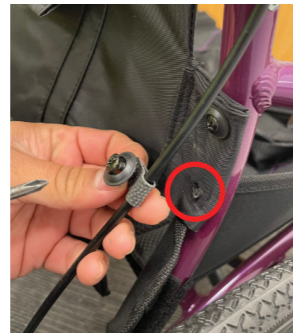

- 2 With screws removed, align the seatbelt mounting clip with the frame and fasten it in place with the same screw removed (1).

The screw should go through the mounting clip, upholstery and into the same frame location (both sides).

Ensure it is locked firmly in place to make sure the seatbelt is securely fitted to the frame.



- 3 Adjust the length of the lap belt so that it fits comfortably around the user.



ANTI TIPPERS

WCA848275

TOOLS REQUIRED

Wrench (Included in box)



INSTALLING ANTI TIPPERS

- 1 Twist and remove end cap (both sides).

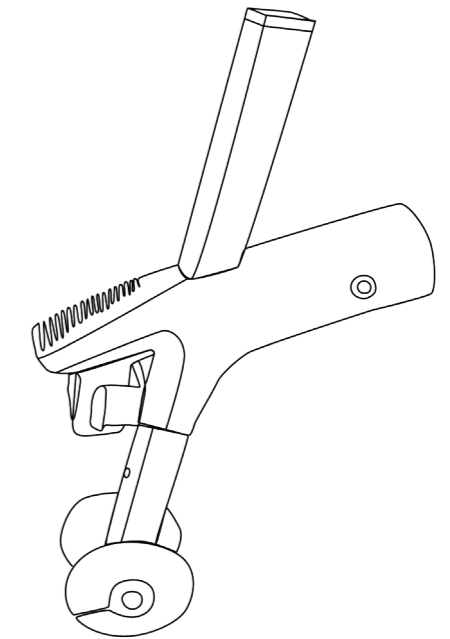

- 2 Remove bolt and nut from tipper. Slide tipper over tube. Place bolt through tipper and tube. Use the wrench to secure the nut.



- 3 The anti-tip wheel height range is adjustable for improved mobility during carer transportation.



13. TROUBLESHOOTING

Wheelchair is steering/pulling to one side	<ul style="list-style-type: none"> Ensure rear wheel quick-release axles are locked to securely in place. This can be checked by raising the rear wheels off the ground and pulling gently outward at the wheel hub. When locked in place the locking balls should be visible at the inner end of the axle sleeve.
	<ul style="list-style-type: none"> Make sure the end user is able to evenly distribute his/her weight on the wheelchair.
	<ul style="list-style-type: none"> Make sure each wheel rotate freely.
Wheelchair is moving slowly	<ul style="list-style-type: none"> Make sure the rear wheels are attached correctly to the frame.
	<ul style="list-style-type: none"> Remove any hair or dirt from castor and rear wheel axles.
	<ul style="list-style-type: none"> Make sure there is not too much weight applied to the castors, otherwise adjust the centre of gravity.
	<ul style="list-style-type: none"> Ensure user clothing is not interfering with movement of the rear wheels. Ensure both brakes are disengaged.
Wheelchair does not turn smoothly	<ul style="list-style-type: none"> Make sure the front fork bolts are not over tightened which can restrict front castor wheel rotation.
	<ul style="list-style-type: none"> Remove any hair or dirt from castor axles.
	<ul style="list-style-type: none"> Ensure both brakes are disengaged.
Brakes are not working properly	<ul style="list-style-type: none"> Check distance between tyres and brake foot is sufficient such that the requisite amount of force can be applied to the tyre surface to stop it moving when the brake is in the engaged position.
Wheelchair cannot be opened or folded easily	<ul style="list-style-type: none"> Clean the crossbar under the seat and apply some grease.
	<ul style="list-style-type: none"> Check that nothing has become lodged under the seat or in and around the cross bar mechanism.
	<ul style="list-style-type: none"> Check foot plates are folded up.

Correct adjustment of the wheelchair is essential for the successful and safe use of this product. Should assistance be required, contact Aidacare.

14. CARE & MAINTENANCE

MAINTENANCE SCHEDULE

Weekly	Periodically	Yearly	Serviceable Components
<ul style="list-style-type: none"> Check brakes are functioning properly Check all fastenings such as nuts, bolts and hinges are fastened correctly and functioning normally 	<ul style="list-style-type: none"> Check for signs of wear on front castors Check for signs of wear on rear tyres 	<ul style="list-style-type: none"> Service to be completed by authorised Aspire service agent 	<ul style="list-style-type: none"> Wheels & Tyres Forks Axles Armrest receivers Seat sling Footrest mounts Footplates Armrest Pads

CARE FOR YOUR CHAIR

- Check tyre condition at least twice per month.
- Check that rear wheel spokes are not loose. Loose wheel spokes can reduce the strength of the rims and must be safely adjusted by a qualified technician.
- Always keep rear wheel axles clean and free from dirt and hair build up.
- Brakes should be checked regularly.

CLEANING INSTRUCTIONS

- Clean the wheelchair regularly with a damp cloth
- Use a mild washing agent and warm water for excess dirt build-up
- DO NOT** use harsh abrasive or bleach-based agents which may cause damage or discolouration. **DO NOT** use the wheelchair if damages are found on the seat or backrest upholstery.
- Dry with a soft cloth

Should you have any doubts about the correct functioning of the wheelchair or any of its components, please contact Aidacare.

15. WARRANTY

5 YEARS WARRANTY
Frame

1 YEAR WARRANTY
Components

Aspire Vida Wheelchairs come with a 5-year warranty (frame) and a 1 year warranty (components).

Please keep purchase invoice as proof of warranty commencement.

This product carries a warranty that varies by component part. The frame and cross frame carry a 5-year warranty, and all other components except consumables (armrest pads, tyres, castors, and upholstery) carry a 1-year warranty. Consumable parts (armrest pads, tyres, castors and upholstery) carry a 1 year warranty against manufacturer defect only, and do not cover wear and tear through use.

For further information contact Aidacare.

16. COMPLIANCE

This Wheelchair range is manufactured in ISO compliant production facilities in P.R China to strict quality control standards.

Aspire wheelchairs are manufactured and independently tested to the market relevant compliance standards.

Labels on the wheelchair address compliance requirements and users should familiarise themselves with these prior to use.

17. SERVICE MAINTENANCE & CUSTOMISATION

FOR ALL ENQUIRIES PLEASE CONTACT YOUR LOCAL AIDACARE BRANCH

SPARE PARTS

Aidacare stock replacement parts for the Aspire wheelchair range. All replacement of parts should be completed by Aidacare or authorised Aspire service technician. The term parts includes but is not limited to: tyres, brakes, armrests, footrests and upholstery.

A complete parts list is available upon request.

CUSTOMISATION AND MODIFICATION

All wheelchair customisation, modifications and or alterations made to this product are considered as "custom" changes. These may cause the product to no longer meet safety standards and should be considered prior to commencement.

Any customisation or modification of the wheelchair is not warranted by Aidacare and will void warranty.

18. RECYCLING INFORMATION

Aspire VIDA Wheelchairs are made from metal and plastic components. The chair can be recycled via standard processes in your city of use.

19. MANUFACTURER, UK REPRESENTATIVE AND IMPORTER DETAILS

If you have any questions, you can contact:



Manufacturer:

Aidacare Pty Ltd

ABN 40 134 833

Building 3A, 1 Moorebank Avenue,
Moorebank NSW 2170
Australia

1300 133 120 | product@aidacare.com.au

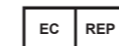

EU Representative:

**European Healthcare & Device Solutions
(Ireland) Ltd**

Stratton House, Bishopstown Road
Cork T12 Y9TC
Ireland

info@europeandevicesolutions.eu



Importer:

Aidacare Ltd

Registration 13785408

Arcadia House, Maritime Walk, Ocean Village,
Southampton SO14 3TL
United Kingdom

01622 541235 | info@aidacare.co.uk

AIDACARE PTY LTD

Building 3A, 1 Moorebank Avenue,
Moorebank NSW 2170
Australia

1300 133 120 | aidacare.com.au

AIDACARE LIMITED

Arcadia House, Maritime Walk,
Ocean Village, Southampton SO14 3TL
United Kingdom

01622 541235 | aidacare.co.uk

MADE IN PRC

ASUM89.18 081123

